



Fantastic Finishes & More



What's New for 2008



Celebrate 50 years of Fantastic Finishes with Scotch-Brite™ brand products. 3M first invented and introduced the category of ‘non-woven abrasives’ in 1958 which has grown to include a full family of hand pads, wheels, discs and bristle products — all delivering the easiest way to a fantastic finish. Look for promotions throughout the year to introduce Met Fab shops to new Scotch-Brite products, like the Light Grinding and Blending Discs or reacquaint them with the “tried and true” members of the Scotch-Brite product family. See notations throughout the catalog of special “future focus” products.



Scotch-Brite™ Light Grinding and Blending Discs

This remarkable, new Scotch-Brite™ disc removes and blends grade 36 scratches and finer while lasting an amazingly long time. In addition, in some paint prep applications, entire steps can be removed from the process! You have to see it to believe it works this well. Put it to the test and find out for yourself. See pages 16 and 20 for more details.



3M™ Cut-off Wheels

Expect a steady flow of new conventional bonded abrasives from 3M, starting with new 3M™ Premium and General Purpose Cut-off Wheels. Available in 4" & 6" sizes, these new wheels expand the line and provide options whether you're looking for price or top performance. See page 11 for more details.



3M™ Portable Utility Cloth Roll 314D

A handy new package for 3M Utility Cloth roll makes it easy to dispense, convenient to carry and a “must have” for anyone involved in MRO applications. Toss the entire roll in the tool box and it stays clean and oil free. See page 40.



From around 3M Industrial Business...

Look for a new section of Speciality Tapes from 3M shown on page 64, and new personal safety options, such as the 3M™ Portable Gas Detector shown on page 73, and the 3M™ Speedglas™ Super Light Helmet and Filter shown on page 72.

New Products



Table of Contents

Discs

3M™ Fibre Discs, Flap Discs and Grinding Wheels Selection Guide	4
3M™ Fibre Discs	5–7
3M™ Flap Discs	8–9
3M™ Bonded Type 27 Wheels	10
3M™ Cut-Off Wheels	11
3M™ Roloc™ Discs Selection Guide	12
3M™ Roloc™ Discs	13–16
Scotch-Brite™ LGB Discs	16
Scotch-Brite™ Roloc™ Discs	17–18
Scotch-Brite™ Roloc™ Surface Conditioning Discs	17
Scotch-Brite™ Roloc™ SL Surface Conditioning Discs	17
Scotch-Brite™ Roloc™ SE Surface Conditioning Discs	17
Scotch-Brite™ Roloc™ PD Surface Conditioning Discs	17
Scotch-Brite™ Roloc™ Bristle Discs	18
Scotch-Brite™ Roloc™ EXL Unitized Wheels	18
Scotch-Brite™ Discs Selection Guide	19
Scotch-Brite™ LGB Discs	20
Scotch-Brite™ Discs	20–22
Scotch-Brite™ Surface Conditioning Discs (Hook-and-Loop)	20
Scotch-Brite™ SL Surface Conditioning Discs	21
Scotch-Brite™ SL Surface Conditioning Discs, TN Quick Change	21
Scotch-Brite™ SE Surface Conditioning Discs	21
Scotch-Brite™ PD Surface Conditioning Discs	21
Scotch-Brite™ Clean & Strip Discs	21
Scotch-Brite™ Clean & Strip XT Discs, TN Quick Change	21
Scotch-Brite™ Coating Removal Discs (Hook-and-Loop)	21
Scotch-Brite™ High Strength Discs	22
Scotch-Brite™ Hookit™ Clean and Finish Discs	22
Scotch-Brite™ Bristle Discs	22
3M™ Stikit™ and PSA Discs Selection Guide	23
3M™ Stikit™ Discs	23–24
3M™ PSA Discs	25–26

Belts

3M™ Belt Selection Guide	27
3M™ Backstand, Benchtop and Portable Tool Belts	27–31

Wheels

3M™ Wheel Selection Guide	32
Scotch-Brite™ EXL Unitized Deburring Wheels	32
Scotch-Brite™ Convolute Wheels	33
3M™ Flap Wheels	34

Specialty Products

Bench Area Products	35–36
Scotch-Brite™ Radial Bristle Discs	35
Scotch-Brite™ Stars	35
Scotch-Brite™ Flap Brushes	35
Scotch-Brite™ Combi Wheel	36
Scotch-Brite™ Clean & Strip Discs	36
Scotch-Brite™ CPD5-R and CPD5-S Discs	36
3M™ Cartridge Rolls	37
3M™ Evenrun Bands	38

Hand Sanding

3M™ Utility Cloth Sheet & Roll Selection Guide	41
3M™ Utility Cloth Sheets & Rolls	39–41
3M™ Wetordry™ Sheet Selection Guide	40
3M™ Wetordry™ Sheets	40
3M™ Paper Sheet Selection Guide	41
3M™ Paper Sheets	41
Scotch-Brite™ Hand Pad, Sheet Roll and Roll Selection Guide	42
Scotch-Brite™ Hand Pads	42
Scotch-Brite™ Rolls	43

3M™ Intro Kits

3M™ Intro Kits	44
--------------------------	----

Abrasive Grade Reference Charts

Abrasive Grade Comparison Guide	45
Scotch-Brite™ Disc Grade Guide	45

Adhesives & Tapes

Adhesive Selection Guide	46
3M™ Non-Structural Adhesives	47–50
3M™ Aerosol Adhesives	47
3M™ Scotch-Grip™ Adhesives	48
3M™ Scotch-Weld™ Neoprene Adhesives	49
3M™ Sealants	50
Structural Adhesives	50–55
3M™ Scotch-Weld™ Epoxy and Acrylic Adhesives	50–51
3M™ EPX™ Scotch-Weld™ Applicators & Accessories	52
3M™ Scotch-Weld™ Instant Adhesive	52
3M™ Scotch-Weld™ Threadlockers	53
3M™ Scotch-Weld™ Thread Sealants	54
3M™ Scotch-Weld™ Gasket Makers	54
3M™ Scotch-Weld™ Retaining Compounds	55
3M™ Protective Tapes	56–57
3M™ VHB™ Tapes	58
3M™ Masking Products	59–61
3M™ High Strength Tapes	62–63
Scotch® Filament Tape Dispensers	63
3M™ Specialty Tapes	64
Scotch® Box Sealing Tapes & Dispensers	65–67
3M™ Duct Tapes	67

Safety Products

3M™ Particulate Respirators	68–69
3M™ Full and Half Facepiece Respirators	70
3M™ Filters, Retainers and Cartridges	71
3M™ Welding Products	72–73
3M™ Portable Gas Detectors	73
3M™ Hearing Protection	74–75
3M™ Protective Eyewear	76
Warnings	77

Maintenance and Repair

3M™ Sorbents	78
3M™ Cleaners	79
3M™ Concrete Repair	80
3M™ Electrical Products	80
3M™ Facility Care Products	81

NOTE: Pricing is per individual unit, unless otherwise indicated. Prices subject to change without notice. Access to products in this catalog is governed by existing 3M Distribution Agreements at the time of catalog printing. 3M™ Protective Tapes are custom-ordered products.

3M™ Fibre Discs, Flap Discs and Grinding Wheels Selection Guide

3M™ Fibre Discs — Select for fast cutting when grinding and blending.

	On Mild Steel	Backing	Mineral		On Stainless Steel	Backing	Mineral
Good	281C	Fibre	AlOx	Good	501C	Fibre	AZ
Better	501C	Fibre	AZ	Better	785C	Fibre	3M™ Cubitron™ Abrasive Grain/AlOx
Best	988C	Fibre	3M™ Cubitron™ Abrasive Grain	Best	985C	Fibre	3M™ Cubitron™ Abrasive Grain

3M™ Flap Discs — Select for extended life and single-step grinding/blending.

	On Mild Steel	Backing	Mineral		On Stainless Steel	Backing	Mineral
Better	563D	Cotton	AZ	Better	747D	Cotton	3M™ Cubitron™ Abrasive Grain/AlOx
Best	—	—	—	Best	947D	Cotton	3M™ Cubitron™ Abrasive Grain

3M™ Bonded Type 27 and Type 29 Wheels — Select for a high rate of stock removal and long life.

DO NOT USE ON TOOLS WITHOUT GUARDS.

	On All Metals	Backing	Mineral	Wheel Format	Key Feature
Better	3M	N/A	AlOx	3M™ Depressed Center Wheels	More Rigid; Long Life
Best	3M™ Green Corps™	N/A	3M™ Cubitron™ Abrasive Grain	3M™ Depressed Center Wheel	More Rigid; Longest Life
				3M™ Flexible Grinding Wheel	Runs Smoother; Grinds Faster
				3M™ Cutting and Grinding Wheel	Dual Purpose; Cuts and Grinds

3M™ Fibre Discs



179577

3M™ Fibre Discs 281C

- General purpose disc for weld removal, grinding and blending



159094

Dia. x Ctr. Hole	Max. RPM	Grade	UPC (051144-)	Min./Case
4-1/2" x 7/8"	13,300	24	85959-7	25
		36	85960-3	
		50	85961-0	
		60	85962-7	
		80	85963-4	
5" x 7/8"	12,000	24	85966-5	25
		36	85967-2	
		50	85968-9	
		60	85969-6	
		80	85970-2	
7" x 7/8"	8,600	24	85973-3	25
		36	85974-0	
		50	85975-7	
		60	85976-4	
		80	85977-1	

3M™ Fibre Discs 501C

- Versatile disc for use on a wide variety of metals



51773

Dia. x Ctr. Hole	Max. RPM	Grade	UPC (051111-)	Min./Case
4-1/2" x 7/8"	13,300	24	50409-3	25/100
		36	50413-0	
		50	50414-7	
		60	50415-4	
		80	50416-1	
5" x 7/8"	12,000	24	50410-9	
		36	50412-3	
		50	50420-8	
		60	50421-5	
		80	50422-2	
7" x 7/8"	8,600	24	50411-6	
		36	50426-0	
		50	50425-3	
		60	50427-7	
		80	50428-4	



3M™ Fibre Discs (cont.)

3M™ Fibre Discs 988C

- 3M's best premium disc for long-lasting performance for mild steel grinding

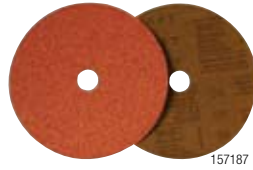

157187

Dia. x Ctr. Hole	Max. RPM	Grade	UPC (051111-)	Min./Case
5" x 7/8"	12,000	24	55746-4	25/100
		36	55743-3	
		50	55742-6	
		60	55741-9	
		80	55740-2	
		P100	55752-5	
		P120	55751-8	
7" x 7/8"	8,600	24	55964-2	
		36	55965-9	
		40	55966-6	
		50	55967-3	
		60	55739-6	
		80	55968-0	
		P100	55969-7	
9-1/8" x 7/8"	6,600	24	55744-0	
		36	55735-8	
		50	55733-4	
		P120	55749-5	

3M™ Fibre Discs 785C

- An excellent starting point for stainless steel
- Includes a grinding aid for cooler running



60875

Dia. x Ctr. Hole	Max. RPM	Grade	UPC (051144-)	Min./Case
4-1/2" x 7/8"	13,300	36	80660-7	25/100
		50	80661-4	
		60	80662-1	
		80	80663-8	
		P120	80665-2	
5" x 7/8"	12,000	24	13931-6	
		36	13930-9	
		50	13928-6	
		80	13926-2	
		P100	80654-6	
7" x 7/8"	8,600	P120	80655-3	
		24	13937-8	
		36	13936-1	
		50	13934-7	
		60	13933-0	
		80	13932-3	
		P100	80656-0	
P120	80657-7			

3M™ Fibre Discs 985C

- 3M's most aggressive mineral makes this the best choice for a long-lasting, premium disc for stainless steel
- Includes a grinding aid for cooler running

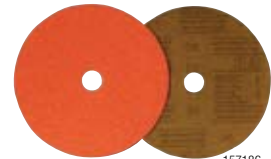

157186

Dia. x Ctr. Hole	Max. RPM	Grade	UPC (051111-)	Min./Case
5" x 7/8"	12,000	36	55767-9	25/100
		50	55780-8	
		60	55776-1	
		80	55779-2	
7" x 7/8"	8,600	24	55971-0	
		36	55972-7	
		50	55973-4	
		60	55974-1	
		80	55975-8	

157186

Accessories — 3M™ Fibre Discs

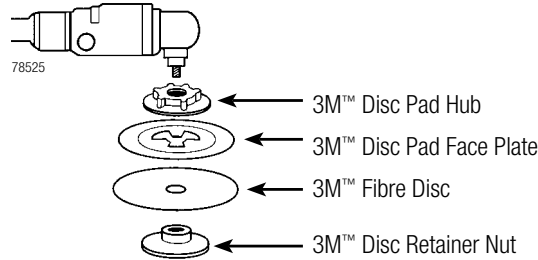

3M™ Disc Pad Hub

- Plastic hubs with 5/8"–11 metal insert
- Use with 3M™ Disc Pad Face Plates



Diameter	Description	UPC (051144-)	Min./Case
2-1/2"	Use with all size face plates	45205-7	5/10
4-1/2"	Use with 7" face plates only	45190-6	
2-1/2"	Use with all size face plates, tool shaft length 1/2" or less	88743-9	

3M™ Disc Pad Face Plates

- Backup plates for fibre discs
- Color coded by density
- Ribbed plates result in cooler running discs
- Use harder face plates for heavier stock removal applications



Diameter	Face Type	Max. RPM	Hardness	UPC (051144-)	Min./Case
4-1/2"	Smooth	13,300	Medium – Gray	13325-3	5/25
			Hard – Black	14270-5	
5"	Ribbed	12,000	Medium – Gray	81734-4	
			Hard – Black	81733-7	
			Extra Hard – Red	81732-0	
7"	Ribbed	8,600	Medium – Gray	80516-7	
			Hard – Black	80515-0	
			Extra Hard – Red	80514-3	

3M™ Disc Retainer Nuts

- For use with all 3M™ Disc Pad Face Plates, Disc Pads, and Disc Pad Hubs
- Nuts have 5/8"–11 threaded arbor hole in three depths to accommodate grinder shaft lengths



Depth	UPC (051144-)	Qty./Case
3/8"	05622-4	10
1/2"	05621-7	
5/8"	05620-0	
Depth	UPC (051111-)	Qty./Case
5/16"	51047-6	10

3M™ Disc Holder Adapter No. 9

- Will convert a grinder with M10–1.25, M10–1.5, or 3/8"–24 external threaded shaft to a 5/8"–11 external threaded shaft



Thread Size	UPC (048011-)	Qty./Case
M10–1.25 INT	22971-3	10
M10–1.50 INT	22972-0	
3/8"–24 INT	22970-6	



3M™ Flap Discs



360842

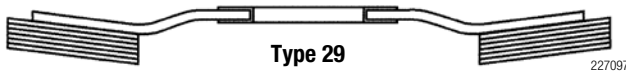

227097

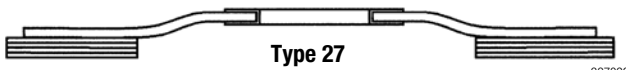

227096

Legend:	Mild Steel	Stainless Steel
----------------	------------	-----------------

3M™ Flap Discs 563D ■

- Type 29
- Angled for better surface coverage
- Fast cutting disc with exceptionally long life
- Works great on a wide variety of metals
- Available in convenient “Quick Change” option
- Alumina zirconia



51702

Dia. x Ctr. Hole	Max. RPM	Grade	UPC (051111-)	Qty./Case
4-1/2" x 7/8"	13,300	P36	50467-3	10
		P40	50468-0	
		P60	50469-7	
		P80	50470-3	
		P120	50471-0	
7" x 7/8"	8,600	P36	50472-7	5
		P40	50473-4	
		P60	50474-1	
		P80	50475-8	

3M™ Flap Discs 563D Quick Change ■

- Type 29
- Fast cutting disc with exceptionally long life
- Works great on a wide variety of metals
- Threaded for easy disc changes



159103

Dia. x Ctr. Hole	Max. RPM	Grade	UPC (051111-)	Qty./Case
4-1/2" x 5/8"-11	13,300	P36	50769-8	10
		P40	50770-4	
		P60	50771-1	
		P80	50772-8	
7" x 5/8"-11	8,600	P36	50774-2	5
		P40	50775-9	
		P60	50776-6	
		P80	50777-3	

3M™ Flap Discs 747D ■

- Type 27
- Premium 3M™ Cubitron™ Abrasive Grain provides extended cut and life on hard metals



84696

Dia. x Ctr. Hole	Max. RPM	Grade	UPC (051111-)	Qty./Case
4-1/2" x 7/8"	13,300	36	49613-8	10
		50	49614-5	
		60	49615-2	
		80	49616-9	
		P120	49617-6	
7" x 7/8"	8,600	36	49608-4	5
		50	49609-1	
		60	49610-7	
		80	49611-4	

3M™ Flap Discs (cont.)

3M™ Flap Discs 947D

- Type 27
- Excellent option for stainless steel finishing
- Premium 3M™ Cubitron™ Abrasive Grain for exceptional cut and life on hard metals
- Available in convenient “Quick Change” option



360834

Dia. x Ctr. Hole	Max. RPM	Grade	UPC (051111-)	Qty./Case
4-1/2" x 7/8"	13,300	40	61187-6	10
		60	61188-3	
		80	61189-0	
		120	61190-6	
7" x 7/8"	8,600	40	61195-1	5
		60	61196-8	
		80	61197-5	
		120	61198-2	

3M™ Flap Discs 947D Quick Change

Dia. x Ctr. Hole	Max. RPM	Grade	UPC (051111-)	Qty./Case
4-1/2" x 5/8"-11	13,300	40	61191-3	10
		60	61192-0	
		80	61193-7	
		120	61194-4	
7" x 5/8"-11	8,600	40	61199-9	5
		60	61200-2	
		80	61201-9	
		120	92301-6	

Accessories — 3M™ Flap Discs/ Bonded Wheels

Flap Disc/Grinding Wheel Adapter Nut

- Used for securing 4-1/2" diameter flap discs or 4-1/2" and 7" flexible grinding wheels to right angle tool with a 5/8"-11 threaded shaft



158149

Thread Size	UPC (051144-)	Min./Case
5/8"-11	88765-1	1 Pair/5 Pairs

Flap Disc Holder

- Backup plate for 7" diameter type 27 flap discs

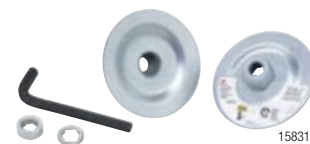

158318

Dia. x Thread Size	UPC (051144-)	Qty./Case
4" x 5/8"-11	88769-9	1

Accessories — 3M™ Bonded Type 27 Wheels

Flexible Grinding Wheel Backup Pad

- Required for safe operation of Flexible Grinding Wheels with 7/8" center hole



159101

Dia. x AH	UPC (051111-)	Qty./Case
3-3/8" x 7/8" Use with 4-1/2" only	51046-9	100
4-5/8" x 7/8" Use with 7" only	51045-2	



3M™ Bonded Type 27 Wheels

3M™ Green Corps™ Wheels contain



DO NOT USE BONDED WHEELS ON TOOLS WITHOUT GUARDS.

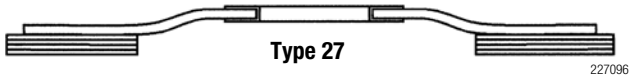

3M™ Green Corps™ Flexible Grinding Wheel

- Type 27
- Bonded abrasive wheel
- Offers a high rate of stock removal in a smoother running wheel
- Available in threaded “Quick Change” option



Dia. x Thk. X AH	Max. RPM	Grade	UPC (051111-)	Qty./Case
4-1/2" x 1/8" x 7/8"	13,300	36	50440-6	40
		46	50442-0	
		60	50443-7	
		80	50444-4	
7" x 1/8" x 7/8"	8,500	36	50445-1	20
		46	50446-8	
		60	50447-5	
		80	50448-2	

3M™ Green Corps™ Flexible Grinding Wheel Quick Change



Dia. x Thk. X AH	Max. RPM	Grade	UPC (051111-)	Qty./Case
4-1/2" x 1/8" x 5/8"-11	13,300	36	51164-0	40
		46	51161-9	
		60	51160-2	
7" x 1/8" x 5/8"-11	8,500	36	51163-3	20

3M™ Green Corps™ Depressed Center Wheel

- Type 27
- Bonded abrasive wheel
- Provides a high rate of stock removal and long life

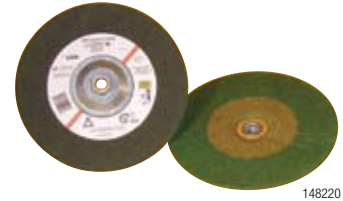

Dia. x Thk. X AH	Max. RPM	Grade	UPC (051111-)	Qty./Case
4-1/2" x 1/4" x 7/8"	13,300	24	55991-8	40
		36	55992-5	
4-1/2" x 1/4" x 5/8"-11	13,300	24	55960-4	
		36	55961-1	
7" x 1/4" x 7/8"	8,500	24	55989-5	20
		36	55990-1	
7" x 1/4" x 5/8"-11	8,500	24	55958-1	
		36	55959-8	

Also in Aluminum Oxide—

3M™ Depressed Center Wheel

- Type 27
- Bonded abrasive wheel
- Provides a high rate of stock removal and long life
- Do not use on tools without guards



Dia. x Thk. X AH	Max. RPM	Grade	UPC (051135-)	Qty./Case
4-1/2" x 1/4" x 7/8"	13,300	24	92312-2	40
4-1/2" x 1/4" x 5/8"-11			92314-6	
7" x 1/4" x 7/8"	8,500		92313-9	20
7" x 1/4" x 5/8"-11			92315-3	

3M™ Green Corps™ Cutting and Grinding Wheel

- Type 27
- Grind and cut with one wheel
- Contains 3M™ Cubitron™ Abrasive Grain for added durability
- Do not use on tools without guards



Dia. x Thk. X AH	Max. RPM	Grade	UPC (051135-)	Qty./Case
4-1/2" x 1/8" x 7/8"	13,300	36	92316-0	40
4-1/2" x 1/8" x 5/8"-11			92318-4	
7" x 1/8" x 7/8"	8,500		92317-7	20
7" x 1/8" x 5/8"-11			92319-1	

3M™ Cut-Off Wheels



424849

3M™ Green Corps™ Cut-Off Wheels

- 3M™ Cubitron™ Abrasive Grain
- Provides high cut rates and long life on most material, including fiberglass, stainless steel and mild steel
- **Do not use on tools without guards**
- Must be used with ANSI-approved flanges for Type 1 cut-off wheels



213792

Dia. x W x AH	Max. RPM	UPC (051144-)	Min./Case
2" x 1/16" x 1/4"	42,000	83487-7	50/50
3" x 1/32" x 1/4"	35,000	82238-6	
Dia. x W x AH	Max. RPM	UPC (051131-)	Min./Case
3" x 1/32" x 3/8"	35,000	01989-8	5 wheels/pack 10 packs/case
		01985-0	50/50
3" x 1/16" x 3/8"	28,000	01990-4	5 wheels/pack 10 packs/case
		01986-7	50/50
Dia. x W x AH	Max. RPM	UPC (051144-)	Min./Case
4" x 1/16" x 3/8"	21,000	83488-4	50/50
4" x 1/32" x 1/4"	26,250	88755-2	
Dia. x W x AH	Max. RPM	UPC (051131-)	Min./Case
4" x 1/32" x 3/8"	26,250	01994-2	50/50
Dia. x W x AH	Max. RPM	UPC (051141-)	Min./Case
4-1/2" x 3/64" x 7/8"	13,300	20275-4	50/200
4-59/64" x 3/64" x 7/8"	12,200	20276-1	

For safe applications using cut-off wheels, refer to ANSI B-7.1 for details. ALWAYS use appropriate wheel guards. Refer to ANSI B-186.1 for guarding requirements.

6" 3M™ High Performance Cut-Off Wheel



- Great on stainless steel
- 3M™ Cubitron™ Abrasive Grain
- Provides high cut rates and long life on most materials
- **Do not use on tools without guards**
- Must be used with ANSI-approved flanges for Type 1 cut-off wheels

Dia. x W x AH	Max. RPM	UPC (051141-)	Min./Case
6" x .045" x 7/8"	10,200	20349-2	50/100

Also in Aluminum Oxide—

3M™ General Purpose Cut-Off Wheels, 4" and 6"



- Good value, especially in mild steel applications
- Great life over comparable aluminum oxide wheels
- **Do not use on tools without guards**
- Must be used with ANSI-approved flanges for Type 1 cut-off wheels

Dia. x W x AH	Max. RPM	UPC (051141-)	Min./Case
6" x .045" x 7/8"	10,200	20447-5	50/100
4" x 1/32" x 3/8"	21,000	20448-2	50/200
4" x 1/16" x 3/8"		20449-9	

Accessories — 3M™ Cut-Off Wheels

3M™ Cut-Off Wheel Adapter Flange

























- For 4-1/2", 5" and 6"
- 5/8"–11 adaptor for use with Type 1 wheels with a 7/8" arbor

Diameter	UPC (051141-)	Min./Case
1.688"	20211-2	5



360835

Roloc™ Disc Selection Guide

Disc Product	Attachment System			Application							Metal Type						
				Grinding	Light Grinding	Blending	Deburring	Finishing	Cleaning	Stainless Steel	Aluminum	Carbon Steel	Cast Iron	Titanium	Nickel Alloy	Non-Ferrous (Brass/Bronze)	
361F				●	●	●	●			●	●	●	●		●	●	
461F					●	●	●	●						●			
777F				●	●	●	●			●	●	●		●	●	●	
963G				●	●	●	●					●	●				
977F				●	●	●	●			●	●			●	●		
501C				●	●	●	●					●	●			●	
785C				●	●	●	●			●	●				●		
983C/988C				●	●		●					●	●				
988R	TR (one piece construction) 			●	●		●				●	●	●			●	
Scotch-Brite™ Roloc™ Light Grinding and Blending Disc	TR 				●	●	●			●	●	●	●	●	●	●	
Scotch-Brite™ Roloc™ Surface Conditioning Disc						●		●	●	●	●	●	●	●	●	●	
Scotch-Brite™ Roloc™ SL Surface Conditioning Disc	Roloc TR (plastic button) 					●		●		●	●	●	●	●	●	●	
Scotch-Brite™ Roloc™ SE Surface Conditioning Disc	Roloc TR (plastic button) 					●	●					●	●				
Scotch-Brite™ Roloc™ PD Surface Conditioning Disc	Roloc TR (plastic button) 					●		●	●	●	●	●	●			●	
Scotch-Brite™ Roloc™ Bristle Disc	Roloc TR (plastic button) 								●	●	●	●	●			●	
Scotch-Brite™ Roloc™ EXL Unitized Wheels	Roloc TR (plastic button) 						●	●		●	●	●	●	●	●	●	

3M™ Roloc™ Discs



159105

3M™ Roloc™ Discs provide a fast, efficient method for grinding, blending, leveling and finishing on all types of metal. They lock securely in place with just a half twist...another half twist and they're off. Each disc is color coded by grade. (This does not include 3M Roloc TSM or 988R products.)

3M™ Roloc™ Disc Button Color/Grade Chart

24/Black	80/Yellow	180/Brown
36/Brown	100/Blue	240/Green
50/Green	120/White	
60/Orange	150/Black	

Legend:	Mild Steel	Stainless Steel
----------------	------------	-----------------

3M™ Roloc™ Disc 361F

- Aluminum Oxide – YF wt. Cloth
- General purpose grinding, blending and finishing on all metals



159104

Diameter	Max. RPM	Grade	UPC (051144-)	Min./Case
Roloc TR (Plastic Button)				
1"	30,000	36	11412-2	50/500
		50	11411-5	
		60	11417-7	
		80	11416-0	
		P100	11415-3	
		P120	11414-6	
1-1/2"	30,000	36	22396-1	50/500
		50	11137-4	
		60	22397-8	
		80	22407-4	
		P100	22408-1	
		P120	22409-8	

3M™ Roloc™ Disc 361F (cont.)

Diameter	Max. RPM	Grade	UPC (051144-)	Min./Case
Roloc TR (Plastic Button)				
2"	25,000	24	11000-1	50/200
		36	22398-5	
		50	22399-2	
		60	22400-5	
		80	22401-2	
		P100	22402-9	
		P120	22403-6	
		P150	14559-1	
		P180	13873-9	
		P240	11419-1	
3"	20,000	24	22392-3	50/200
		36	22393-0	
		50	22394-7	
		60	22395-4	
		80	22404-3	
		P100	22405-0	
		P120	22406-7	
		P150	82244-7	
		P240	11418-4	
		Roloc TSM (Metal Button)		
1-1/2"	30,000	36	49932-0	50/500
		60	49933-7	
		80	49934-4	
		P100	51039-1	
2"	25,000	36	49936-8	50/200
		60	49937-5	
		80	49938-2	
		P100	51034-6	
		P120	49939-9	
3"	20,000	36	51033-9	50/200
		60	49940-5	
		80	49941-2	
		P100	49942-9	
		P120	49943-6	
Roloc TP (Plastic Button)				
3"	20,000	36	76799-1	50/200
		50	76803-5	
		60	76807-3	
		80	76811-0	
Roloc TR (Plastic Button)				
4"	12,000	36	76429-7	25/100
		60	11421-4	
		80	11420-7	

3M™ Roloc™ Discs (cont.)

3M™ Roloc™ Disc 461F ■

- Silicon Carbide – YF wt. Cloth
- Ideal for grinding glass, titanium, and non-ferrous metals



Diameter	Max. RPM	Grade	UPC (051144-)	Min./Case
Roloc TR (Plastic Button) 				
2"	25,000	P60	12956-0	50/200
		P80	12954-6	
3"	20,000	P60	12957-7	
		P80	12955-3	

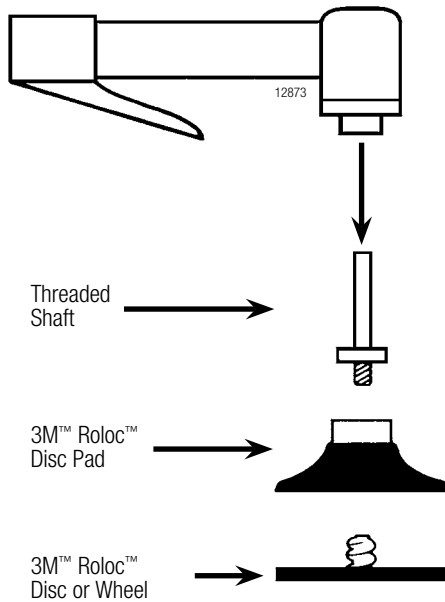



3M™ Roloc™ Disc 777F ■

- 3M™ Cubitron™ Abrasive Grain
- Cloth backing
- Grinding aid



Diameter	Grade	UPC (051144-)	Min./Case
Roloc TR (Plastic Button) 			
1"	36	76622-2	50/500
	50	76623-9	
	60	76624-6	
	80	76625-3	
	P120	80510-5	
1-1/2"	36	76626-0	
	50	76627-7	
	60	76628-4	
	80	14660-4	
	P120	80511-2	
2"	36	76629-1	50/200
	50	76630-7	
	60	76433-4	
	80	14661-1	
	P100	80508-2	
	P120	80512-9	
3"	36	76631-4	
	50	76632-1	
	60	76633-8	
	80	76634-5	
	P100	80509-9	
	P120	80513-6	

Diameter	Grade	UPC (051111-)	Min./Case
Roloc TS (Plastic Button) 			
2"	36	76742-7	50/200
	50	76746-5	
	60	76750-2	
	80	76754-0	
3"	36	76743-4	
	60	76751-9	
	80	76755-7	

Diameter	Grade	UPC (051111-)	Min./Case
Roloc TSM (Metal Button) 			
2"	36	49949-8	50/200
	60	50253-2	
	80	50254-9	
	P120	50256-3	

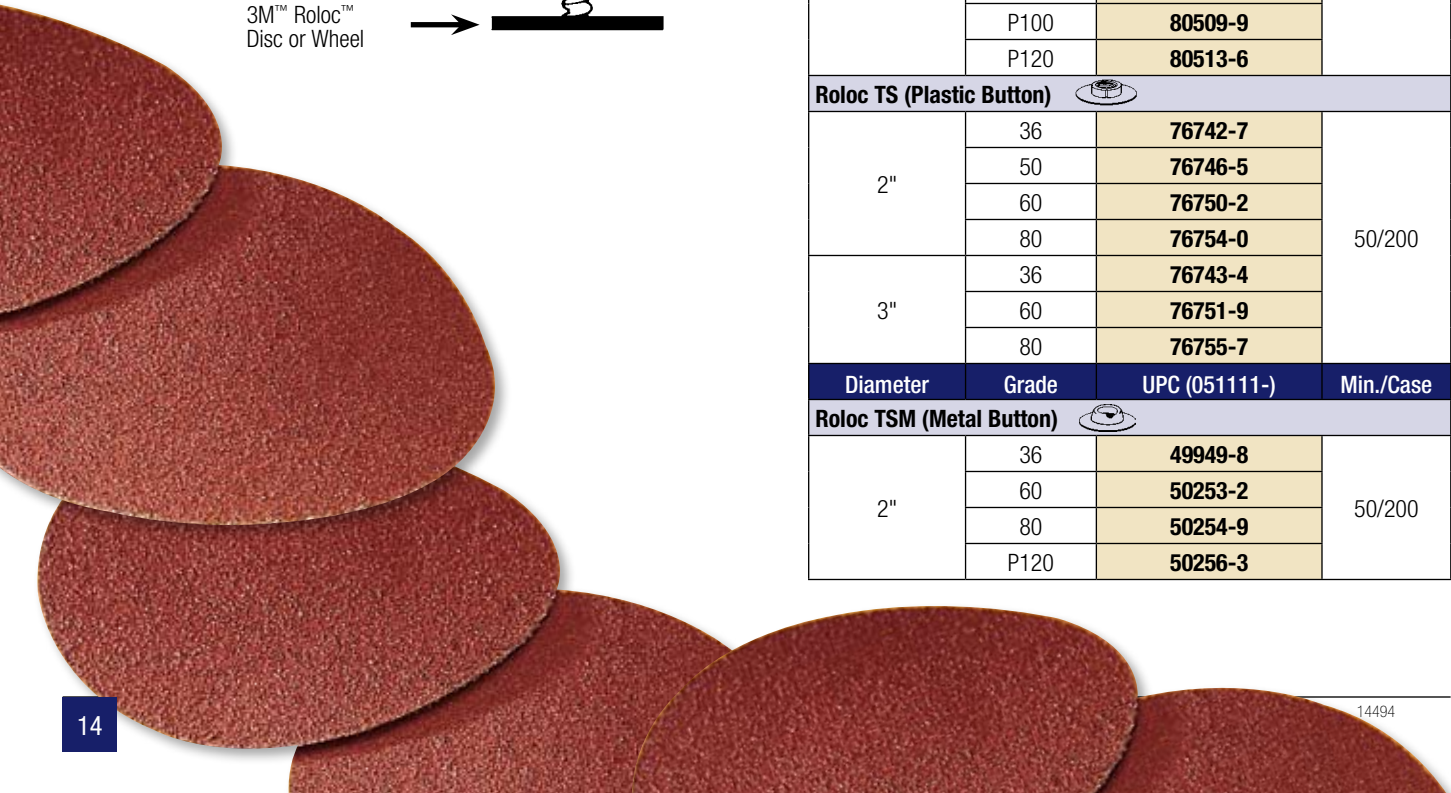

3M™ Roloc™ Discs (cont.)

3M™ Roloc™ Cloth Disc 963G

- 3M™ Cubitron™ Abrasive Grain
- Cloth backing



422747

Diameter	Grade	UPC (051144-)	Min./Case	
Roloc TR (Plastic Button)				
1"	36	11423-8	50/500	
	60	11428-3		
	80	11427-6		
	120	11425-2		
1-1/2"	36	11450-4		
	50	11449-8		
	60	11448-1		
	80	11455-9		
	120	11453-5		
2"	24	11113-8		50/200
	36	11112-1		
	40	76436-5		
	50	11111-4		
	60	11110-7		
	80	11109-1		
	100	11107-7		
	120	11106-0		
3"	24	11108-4		
	36	11105-3		
	50	11104-6		
	60	11103-9		
	80	11102-2		
	100	11101-5		
120	11100-8			

3M™ Roloc™ Disc 977F

- 3M™ Cubitron™ Abrasive Grain
- Grinding aid



422747

Diameter	Max. RPM	Grade	UPC (051144-)	Min./Case
Roloc TR (Plastic Button)				
2"	25,000	36	83587-4	50/200
		60	83588-1	
		80	83589-8	
3"	20,000	60	83591-1	
		80	83592-8	

3M™ Roloc™ Fibre Disc 501C

- Aluminum Zirconia – Fibre
- Versatile disc for use on a wide variety of metals



148181

Diameter	Max. RPM	Grade	UPC (051111-)	Min./Case
Roloc TR (Plastic Button)				
2"	25,000	50	50748-3	50/200
		60	50749-0	
		80	50750-6	
3"	20,000	36	50743-8	
		50	50744-5	
		60	50745-2	
Roloc TSM (Metal Button)				
2"	25,000	36	50755-1	50/200
		50	50756-8	
		60	50757-5	
		80	50758-2	
3"	20,000	36	50751-3	
		50	50752-0	
		60	50753-7	
		80	50754-4	

3M™ Roloc™ Fibre Disc 785C

- 3M™ Cubitron™ Abrasive Grain – Fibre
- An excellent starting point for stainless steel
- Includes a grinding aid for cooler running

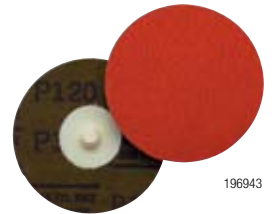

196943



Diameter	Max. RPM	Grade	UPC (051144-)	Min./Case
Roloc TR (Plastic Button)				
3"	20,000	36	85883-5	25/100
		50	85884-2	
		60	85885-9	
		80	85886-6	
		P100	85887-3	50/200
4"	12,000	36	83690-1	25/100
		50	83691-8	
		60	83692-5	
		80	83693-2	
		P100	83694-9	
		P120	83695-6	

3M™ Roloc™ Discs (cont.)

3M™ Roloc™ Fibre Disc 983C/988C

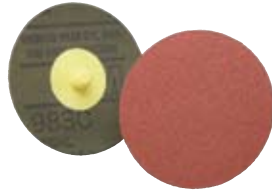
- 3M™ Cubitron™ Abrasive Grain
- Fast cutting
- Long life



Diameter	Max. RPM	Grade	UPC (051144-)	Min./Case
Roloc TR (Plastic Button) 				
2" 983C	25,000	36	22352-7	50/200
		60	22353-4	
		80	22354-1	
3" 983C	20,000	36	22349-7	
		50	85890-3	
		60	22350-3	
		80	22351-0	
Roloc TR (Plastic Button) 				
4" 988C	12,000	36	55753-2	25/100
		50	55754-9	
		60	55755-6	
		80	55756-3	

3M™ Roloc™ Discs 988R

- 3M™ Cubitron™ Abrasive Grain
- Cuts through metal stock to quickly level welds and take on tough jobs in small areas
- A unique single-piece construction that can eliminate button delamination and enhance disc performance



Diameter	Grade	UPC (051141-)	Min./Case
Roloc TR (Plastic Button) 			
2"	24	20626-4	50/200
	36	20627-1	
	50	20628-8	
	60	20629-5	
	80	20630-1	
3"	24	20024-8	
	36	20025-5	
	50	20026-2	
	60	20030-9	
	80	20027-9	

Scotch-Brite™ Roloc™ Light Grinding and Blending Discs



Scotch-Brite™ Roloc™ Light Grinding and Blending Discs

- 3M™ Cubitron™ Abrasive Grain
- Resists edge wear
- Great for light grinding, deburring and blending



Diameter	Max. RPM	Grade	UPC (048011-)	Qty./Case
Roloc TR (Plastic Button) 				
2"	25,000	A CRS HD	60354-4	200
		A CRS SD	60355-1	
3"	18,000	A CRS HD	60356-8	100
		A CRS SD	60357-5	

Scotch-Brite™ Roloc™ Discs



360839





Scotch-Brite™ Roloc™ Surface Conditioning Discs

- Scotch-Brite surface conditioning non-woven web provides a burr-free decorative finish
- Removes grind marks, rust and coatings
- Grade: A VFN – Blue
A MED – Maroon
A CRS – Brown



159116

Diameter	Max. RPM	Grade	UPC (048011-)	Min./Case
Roloc TR (Plastic Button) 				
1-1/2"	30,000	A CRS	08764-1	50/200
		A MED	08765-8	
		A VFN	08766-5	
2"	25,000	A CRS	05528-2	50/200
		A MED	05527-5	
		A VFN	05523-7	
3"	18,000	A CRS	05532-9	25/100
		A MED	05531-2	
		A VFN	05530-5	
4"	12,000	A CRS	12954-9	25/100
		A MED	12953-2	
		A VFN	12952-5	
Roloc TSM (Metal Button) 				
1-1/2"	30,000	A CRS	25775-4	50/200
		A MED	25774-7	
		A VFN	25773-0	
2"	25,000	A CRS	25765-5	50/200
		A MED	25764-8	
		A VFN	25770-9	
3"	18,000	A CRS	25767-9	25/100
		A MED	25766-2	
		A VFN	25780-8	
Roloc TP (Plastic Button) 				
2"	25,000	A CRS	13237-2	50/200
		A MED	13238-9	
3"	18,000	A CRS	13241-9	25/100
		A MED	13242-6	10/100



Scotch-Brite™ Roloc™ SL Surface Conditioning Discs

- Cuts fast without sacrificing finish
- Can last up to twice as long as other surface conditioning discs
- Delivers outstanding value and productivity improvements



341374

Diameter	Max. RPM	Grade	UPC (048011-)	Min./Case
Roloc TR (Plastic Button) 				
2"	25,000	A MED	33791-3	50/200
		A CRS	33793-7	
		A CRS HD	33795-1	200
		A CRS SD	33797-5	
3"	18,000	A MED	33790-6	100
		A CRS	33792-0	
		A CRS HD	33794-4	
		A CRS SD	33796-8	

Many other sizes available upon request.

Scotch-Brite™ Roloc™ SE Surface Conditioning Discs

- Great for edge deburring applications

Diameter	Max. RPM	Grade	UPC (048011-)	Min./Case
Roloc TR (Plastic Button) 				
2"	25,000	A CRS	18081-6	50/200
		A MED	18471-5	
3"	18,000	A CRS	18082-3	25/100
		A MED	18472-2	

Scotch-Brite™ Roloc™ PD Surface Conditioning Discs

- Lofty, open non-woven abrasive disc
- Resistant to loading on soft metals and oily surfaces

Diameter	Max. RPM	Grade	UPC (048011-)	Min./Case
Roloc TR (Plastic Button) 				
2"	25,000	A CRS	60191-5	50/200
		A MED	24287-3	
3"	18,000	A CRS	60192-2	25/100
		A MED	24295-8	

Scotch-Brite™ Roloc™ Discs (cont.)



Scotch-Brite™ Roloc™ Bristle Discs

- Efficiently clean and strip many substances from metal surfaces without damaging the work piece
- An operator can quickly and easily achieve a quality, consistent finish with light pressure
- Grade: 50 – Green; 80 – Yellow; 120 – White

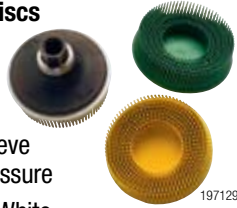

Diameter	Max. RPM	Grade	UPC (048011-)	Min./Case
Roloc TR (Plastic Button)				
2"	25,000	50	18730-3	10/40
		80	18732-7	
		120	18733-4	
3"	15,000	50	18734-1	
		80	18736-5	
		120	18737-2	



Scotch-Brite™ Roloc™ EXL Unitized Wheels

- Strong, efficient products for edge deburring and finishing
- Used with 3M™ Roloc™ or 3M™ Roloc™+ holder pads on a straight shaft or right-angle tool

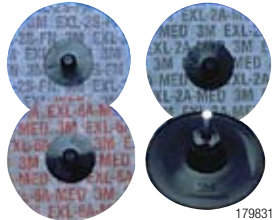

Diameter	Max. RPM	Grade	UPC (048011-)	Qty./Case
Roloc TR (Plastic Button)				
2"	22,100	6 A MED	17190-6	60
		2 A MED	17185-2	
		2 S FIN	17183-8	
3"	15,100	6 A MED	17191-3	40
		2 A MED	17186-9	
		2 S FIN	17184-5	

Accessories — 3M™ Roloc™ Discs

3M™ Roloc™ TR Disc Pads

- Rubber backup pads are available in different diameters and degrees of hardness for various grinding applications
- Pads are internally threaded to receive any standard 1/4"–20 thread shaft

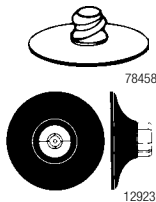

Diameter	Max. RPM	Hardness	UPC (051144-)	Qty./Case
1/4"–20 thread shaft				
1"	30,000	Medium	45101-2	5
1-1/2"		Medium	45099-2	
		Hard	45100-5	
2"	25,000	Medium	45095-4	
		Hard	45096-1	
3"	18,000	Medium	45092-3	
	20,000	Hard	45091-6	
4"	12,000	Medium	45179-1	

3M™ Roloc™ TR Disc Pads (cont.)

Diameter	Max. RPM	Hardness	UPC (051144-)	Qty./Case
5/8"–11 thread shaft				
4"	12,000	Medium	83242-2	5
		Hard	83489-1	

3M™ Roloc™ TS or TSM Disc Pads

- For use with 3M™ Roloc™ TSM discs and "screw on" abrasive discs



Diameter	Max. RPM	Hardness	UPC (051144-)	Qty./Case
1-1/2"	30,000	Medium	77729-7	5
		Hard	77728-0	
2"	25,000	Medium	14211-8	
		Hard	14212-5	
3"	18,000	Medium	14215-6	
	20,000	Hard	14216-3	

3M™ Roloc™ TP Disc Pads

- For use with 3M™ Roloc™ TP discs and with press on type abrasive discs

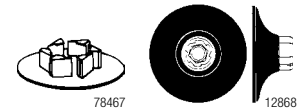

Diameter	Max. RPM	Hardness	UPC (051144-)	Qty./Case
2"	25,000	Medium	14197-5	5
		Hard	14198-2	
3"	18,000	Medium	14201-9	
	20,000	Hard	14202-6	

1/4" Threaded Shaft

- Needed with all 3M™ Roloc™ Disc Pads

Size	UPC (051144-)	Min./Case
1/4" x 1/4" x 20 Thread	45102-9	10/50

3M™ Roloc™ + Holder

- Plastic holder for use with 3M™ Roloc™ Unitized Wheels



L x Shaft Dia	Max. RPM	UPC (048011-)	Qty./Case
1" x 1/4"	25,000	15408-4	5

Optimum Tool Speeds (RPM's) to Maximize 3M™ Roloc™ Disc Cut Rates and Life

Disc Size	Material Type			
	Stainless	Aluminum	Steel	Titanium
1-1/2"	20,000	20,000	30,000	9,000
2"	15,000	15,000	20,000	7,000
3"	10,000	10,000	15,000	4,500
4"	8,000	9,000	9,000	3,000

Scotch-Brite™ Disc Selection Guide

Disc Product	Attachment System	Application						Metal Type						
		Light Grinding	Blending	Deburring	Finishing	Cleaning	Coatings Removal	Stainless Steel	Aluminum	Carbon Steel	Cast Iron	Titanium	Nickel Alloy	Non-Ferrous (Brass/Bronze)
Scotch-Brite™ Light Grinding and Blending Disc	Hook-and-Loop/ TN Quick Change	●	●	●				●	●	●	●	●	●	●
Scotch-Brite™ Surface Conditioning Disc	Hook-and-Loop		●		●	●		●	●	●	●	●	●	●
Scotch-Brite™ SL Surface Conditioning Disc	Hook-and-Loop/ TN Quick Change		●		●			●	●	●	●	●	●	●
Scotch-Brite™ SE Surface Conditioning Disc	Hook-and-Loop		●	●						●	●			
Scotch-Brite™ PD Surface Conditioning Disc	Hook-and-Loop		●		●	●		●	●	●	●			●
Scotch-Brite™ Clean & Strip Discs	Spindle Mount and Quick Change (XT only)					●	●			●	●			
Scotch-Brite™ High Strength Discs	Spindle Mount			●	●	●		●	●			●	●	●
Scotch-Brite™ Coating Removal Discs	Hook-and-Loop					●	●		●	●	●			
Scotch-Brite™ Hookit™ Discs	Hookit™		●		●			●	●					
Scotch-Brite™ Bristle Discs	Quick Change					●	●	●	●	●	●			

Scotch-Brite™ Light Grinding and Blending Discs



Scotch-Brite™ Light Grinding and Blending Discs TN Quick Change



- 3M™ Cubitron™ Grain
- Aggressive, long life, Scotch-Brite finish
- Resistant to edge wear

Diameter	Max. RPM	Grade	UPC (048011-)	Qty./Case
4-1/2"	13,000	A CRS HD	60348-3	50
		A CRS SD	60349-0	
5"	12,000	A CRS HD	60350-6	50
		A CRS SD	60351-3	
7"	8,600	A CRS HD	60352-0	25
		A CRS SD	60353-7	

Scotch-Brite™ Discs



360837

Accessories — Scotch-Brite™ Light Grinding and Blending Discs

3M™ Disc Pad Face Plates

- Use harder face plates for heavier stock removal applications



Diameter	Face Type	Max. RPM	Hardness	UPC (051144-)	Min./Case
4-1/2"	Smooth	13,300	Hard – Black	14270-5	5/25
5"	Ribbed	12,000	Hard – Black	81733-7	
7"	Ribbed	8,600	Hard – Black	80515-0	

51695



Scotch-Brite™ Surface Conditioning Discs (Hook-and-Loop)

- Aluminum Oxide
- Great general purpose surface conditioning disc
- For finishing, cleaning, and light deburring
- Attach and remove easily to 3M™ Hook-and-Loop Backup Pads
- Use with right angle and random orbital tools

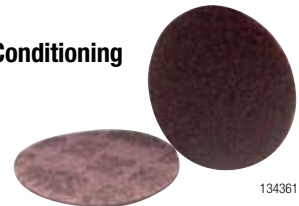

134361

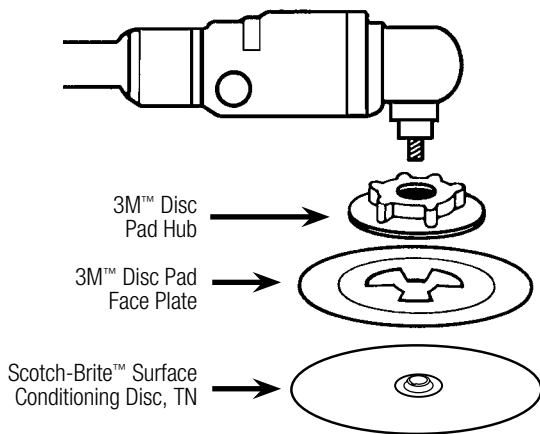

Diameter	Max. RPM	Grade	Color	UPC (048011-)	Min./Case
Hook-and-Loop					
2"	23,000	A CRS	Brown	07458-0	50/200
		A MED	Maroon	07459-7	
		A VFN	Blue	04276-3	
3"	20,000	A CRS	Brown	04120-9	25/100
		A MED	Maroon	04124-7	
		A VFN	Blue	04277-0	
4"	13,000	A CRS	Brown	07450-4	100
		A MED	Maroon	07451-1	
		A VFN	Blue	04278-7	
4-1/2"	13,000	A CRS	Brown	14101-5	50
		A MED	Maroon	14100-8	
		A VFN	Blue	14099-5	
5"	10,000	A CRS	Brown	27674-8	10
				00750-2	50
		A MED	Maroon	27675-5	10
				00643-7	50
		A VFN	Blue	27676-2	10
				04303-6	50
7"	6,000	A CRS	Brown	27677-9	10
				00751-9	25
		A MED	Maroon	27678-6	10
				00645-1	25
		A VFN	Blue	27679-3	10
				04305-0	25

Scotch-Brite™ Discs (cont.)



Scotch-Brite™ SL Surface Conditioning Discs

- Aluminum Oxide
- Highly durable product for aggressive applications
- Cuts fast without sacrificing finish and can work twice as long as other standard surface conditioning discs

Diameter	Max. RPM	Grade	UPC (048011-)	Qty./Case
4-1/2"	13,000	A MED	33805-7	50
		A CRS	33808-8	
		A CRS HD	33811-8	
		A CRS SD	33814-9	
7"	6,000	A MED	33786-9	25
		A CRS	33787-6	
		A CRS HD	33788-3	
		A CRS SD	33789-0	



Scotch-Brite™ SL Surface Conditioning Discs, TN Quick Change

- Use with 3M™ Disc Pad Face Plates and Disc Pad Hubs (see page 7)



Diameter	Max. RPM	Grade	UPC (048011-)	Qty./Case
5"	9,500	A CRS HD	60285-1	50
		A CRS SD	60287-5	50
7"	7,000	A CRS HD	60286-8	25
		A CRS SD	60288-2	25



Scotch-Brite™ SE Surface Conditioning Discs (Hook-and-Loop)

- High cutting surface conditioning disc great for edge deburring applications

Diameter	Max. RPM	Grade	UPC (048011-)	Min./Case
Hook-and-Loop				
4-1/2"	13,000	A CRS	18079-3	50
		A MED	18476-0	
7"	6,000	A CRS	17866-0	25
		A MED	18477-7	

Scotch-Brite™ PD Surface Conditioning Discs (Hook-and-Loop)

- Lofty, open non-woven abrasive disc
- Resistant to loading on soft metals and oily surfaces

Diameter	Max. RPM	Grade	UPC (048011-)	Min./Case
Hook-and-Loop				
7"	6,000	A CRS	19555-1	25
		A MED	60194-6	



Scotch-Brite™ Clean & Strip Discs

- Silicon Carbide – Extra Coarse
- Tough open web, ideal for weld cleaning and removing paint and coatings



Dia. x Ctr. Hole	Max. RPM	Grade	UPC (048011-)	Qty./Case
Use with Mandrel 934				
4" x 1/2"	6,000	S XCS	00941-4	25
6" x 1/2"	4,000		00948-3	15
8" x 1/2"	3,000		00957-5	



Scotch-Brite™ Clean & Strip XT Disc, TN Quick Change

- Silicon Carbide – Extra Coarse
- Mounts quickly to 4-1/2" and 7" grinders
- Tough open web, ideal for weld cleaning and removing paint and coatings
- Use with TN Quick Change back up pad or fibre disc hub and face plate



Dia. x Thk. X AH	Max. RPM	Grade	UPC (048011-)	Min./Case
4-1/2" x 1/2" x 5/8"-11	13,300	S XCS	33194-2	10
7" x 1/2" x 5/8"-11	8,600		33196-6	5



Scotch-Brite™ Coating Removal Discs (Hook-and-Loop)

- Silicon Carbide – Extra Coarse
- Made for right-angle tools from aggressive Clean & Strip web
- Non-loading design ideal for removing rust and coatings
- Mount on hook-and-loop disc pad holders



Diameter	Max. RPM	Grade	UPC (048011-)	Min./Case
Hook-and-Loop				
4-1/2"	12,000	S XCS	18424-1	4/20
			18482-1	40
5"	10,000	S XCS	18355-8	4/20
			18483-8	40
7"	6,000	S XCS	18358-9	2/10
			18485-2	20

Scotch-Brite™ Discs (cont.)

Scotch-Brite™ High Strength Discs

- Aluminum Oxide
- Very conformable discs, ideal for light deburring, cleaning and finishing



Dia. x Ctr. Hole	Max. RPM	Grade	UPC (048011-)	Min./Case
Use with Mandrel 933				
6" x 1/4"	4,000	A VFN	27748-6	10/40
			00666-6	100
Use with Mandrel 934				
6" x 1/2"	4,000	A MED	27745-5	10/40
			04188-9	100
		A VFN	27747-9	10/40
			00665-9	100
8" x 1/2"	3,000	A MED	27746-2	10/20
			03992-3	50
		A VFN	27749-3	10/20
			00672-7	50



Scotch-Brite™ Hookit™ Clean and Finish Discs

- Effective for light to moderate cleaning, satin finishing, scratch blending and paint prep
- Used on aluminum, stainless steel, plastics, wood, and fiber-glass
- Use on random orbital sanders
- Use disc pad holder 05775

Diameter	Max. RPM	Grade	UPC (048011-)	Qty./Case
5"	12,000	A VFN	29292-2	40
		S ULF	29294-6	



Scotch-Brite™ Bristle Discs

- Easily remove paint, stains, adhesives, weld burn, rust and other surface contaminants from large areas



Diameter	Max. RPM	Grade	Color	UPC (048011-)	Qty./Case
4-1/2"	12,000	36	Brown	33054-9	10
		50	Green	24241-5	
		80	Yellow	24242-2	
		120	White	24243-9	

Accessories — Scotch-Brite™ Discs

Disc Pad Holders (Hook-and-Loop)

- For use with Scotch-Brite™ Surface Conditioning Discs



Diameter (x Thread)	Max. RPM	Catalog No.	UPC (048011-)	Qty./Case
2" (1/4" shank)	23,000	922	07494-8	10
3" (1/4" shank)	20,000	923	04132-2	
4-1/2" x 5/8"-11 INT	13,000	9145	14111-4	1
5" x 5/8"-11 INT		915	05680-7	
5" x 5/16"-24 EXT	10,000	905	09448-9	
7" x 5/8"-11 INT	6,000	917	09450-2	
Dia. x Thk. x Thread	Max. RPM	Catalog No.	UPC (051131-)	Qty./Case
5" x 3/4" x 5/16"-24 EXT	12,000	05775	05775-3	10

3M™ TN Quick Change Disc Backup Pad



Dia. x Thread	Max. RPM	UPC (051111-)	Qty./Case
4-1/2" x 5/8"-11 INT	13,300	56573-5	5

Mandrels

- Furnished complete with washers to fit available disc sizes



Length x Shank x Washer Dia.	Catalog No.	UPC (048011-)	Qty./Case
2" x 1/4" x 1"	933	13968-5	5
3-1/16" x 1/4" x 2-1/2"	934	04021-9	1

3M™ Disc Pad Holder (Hook-and-Loop)

- For use with Scotch-Brite™ Coating Removal Discs

Diameter	Max. RPM	Thread	UPC (048011-)	Qty./Case
4-1/2"	13,000	5/8"-11 INT	14111-4	1

3M™ Hookit™ Disc Pad

Diameter x AH	Max. RPM	Thread	UPC (051144-)	Qty./Case
5 x 3/4"	10,000	5/8"-11 INT	85105-8	10
5" x 5/8"			85096-9	
7" x 1"	6,000		13627-8	1

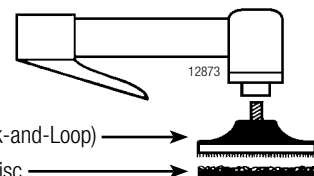

3M™ Disc Holder (Hook-and-Loop)

Surface Conditioning Disc

3M™ Stikit™ and PSA Disc Selection Guide

Disc	Grinding Aid	Application				Backing		Metal Type						
		Grinding	Blending	Deburring	Finishing	Material	Weight	Stainless Steel	Aluminum	Carbon Steel	Titanium	Nickel Alloy	Non-Ferrous (Brass/Bronze)	
214U	Y				●	Paper	A		●	●				
236U	Y		●		●	Paper	C		●	●				
363I	N		●		●	Paper	F		●	●				
763U	N		●		●	Paper	F	●	●	●				
300D	N		●		●	Cloth	J							
241D	N		●		●	Cloth	X							
248D	N	●	●	●		Cloth	X		●	●				●
777F	Y	●	●	●		Cloth	Y	●		●	●	●		

3M™ Stikit™ Disc Roll 236U

- Aluminum Oxide – C wt. Paper
- Discs for paint, primer, wood, metal, plastic and fiberglass
- Strong paper backing provides durability and increased cut rate
- Open coat minimizes loading
- Invisible 3M coating reduces loading



209045

Diameter	Grade	UPC (051144-)	Discs/Roll	Min./Case
Paper Backing				
5"	P80	86488-1	100	1/4
	P100	86489-8		
	P120	86490-4		
	P150	86491-1		
	P180	86492-8		
	P220	86493-5		
	P240	86494-2		
	P320	86495-9		
	P400	86496-6		
	P500	86497-3		
6"	P80	86468-3	100	1/4
	P100	86469-0		
	P120	86470-6		
	P150	86471-3		
	P180	86472-0		
	P220	86473-7		
	P240	86474-4		
	P320	86475-1		
	P400	86476-8		
	P500	86477-5		

3M™ Stikit™ Discs

3M™ Stikit™ White Gold Disc Roll 214U

- Aluminum Oxide – A wt. Paper
- Discs for paint, primer, metal, wood and fiberglass
- Special 3M coating resists loading



13270

Diameter	Grade	UPC (051144-)	Discs/Roll	Qty./Case
Paper Backing				
5"	80A	81802-0	125	10
	P100	81803-7		
	P120	81804-4		
	P150A	81806-8		
	P180A	81808-2		
	P220A	81810-5		
	P240A	81812-9		
	P320A	81997-3		
6"	P400A	81996-6	175	6
	80	86381-5		
	P100	86389-1		
	P120	86382-2		
	P150	86383-9		
	P180	86384-6		
	P220	86385-3		
	P320	86387-7		

3M™ Stikit™ Disc Roll 363I

- Aluminum Oxide – F wt. Paper
- Extra heavy paper backing
- Resin bonded for heat resistance



105480

Diameter	Grade	UPC (051144-)	Discs/Roll	Qty./Case
Paper Backing				
5" x NH	60	21800-4	100	4
	80	21799-1		
	P100	21798-4		
	P120	21797-7		
	P150	21796-0		
6" x NH	P180	21795-3	100	4
	60	21794-6		
	80	21793-9		
	P100	21792-2		
	P120	21791-5		
	P150	21790-8		
	P180	21789-2		

3M™ Stikit™ Discs (cont.)

3M™ Stikit™ Disc Roll 763U

- 3M™ Cubitron™ Abrasive Grain – F wt. Paper
- Extra heavy paper backing

Diameter	Grade	UPC (051144-)	Discs/Roll	Qty./Case
Paper Backing				
5" x NH	60	80942-4	100	4
	80	80943-1		
	P100	80944-8		
P120	80945-5			
6" x NH	60	80946-2		
	80	80947-9		

3M™ Stikit™ Disc 300D

- Aluminum Oxide – J wt. Cloth – Open Coat
- Excellent for use on aluminum and brass
- Cloth backing provides excellent durability
- Open coat resists loading
- Individual discs with liners



148265

Diameter	Grade	UPC (051111-)	Min./Case
Paper Backing			
5"	80	50450-5	50/250
	P100	50451-2	
	P120	50452-9	
	P150	50453-6	
	P180	50454-3	
	P220	50455-0	
6"	80	50459-8	
	P100	50460-4	
	P120	50461-1	
	P150	50462-8	
	P180	50463-5	
	P220	50464-2	

3M™ Stikit™ Disc Roll 241D

- Aluminum Oxide – X wt. Cloth
- Durable cloth backing
- Resin bonded for heat resistance

Diameter	Grade	UPC (051144-)	Discs/Roll	Qty./Case
Paper Backing				
5" X NH	P50	21752-6	100	4
	P60	21751-9		
	P80	21750-2		
	P100	21749-6		
	P120	21748-9		
P180	21746-5			
6" X NH	P60	21762-5		
	P80	21761-8		

Accessories — 3M™ Stikit™ Discs

3M™ Stikit™ Disc Pads

- Lightweight pads have vinyl face for excellent disc adhesion with quick, easy disc removal
- For use with 3M™ Stikit™ discs

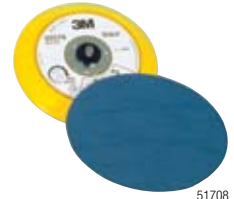

51708

Dia. x Thk. x Thread Size	RPM	OPM*	UPC (051144-)	Min./Case
5" x 3/4" x 5/16"-24	10,000	12,000	05575-3	1/10
6" x 3/4" x 5/16"-24			05576-0	

* Orbits per minute



3M™ PSA Discs



159120

3M™ PSA Cloth Disc 248D

- Aluminum Oxide – X wt. Cloth)
- Heavy-duty, cloth-backed discs for more aggressive applications
- Provides excellent adhesion while removing easily

Diameter	Grade	UPC (051144-)	Min./Case
Cloth Backing			
2"	P36	20913-2	50/200
	P50	20911-8	
	P60	20910-1	
	P80	20909-5	
	P100	20908-8	
	P120	20907-1	
3"	P40	01335-7	
	P50	01334-0	
	P60	01333-3	
	P80	01332-6	
	P100	01331-9	
	P120	01330-2	
5"	P36	20891-3	50/250
	P40	20890-6	
	P50	20889-0	
	P60	20888-3	
	P80	20887-6	
	P100	20886-9	
	P120	20885-2	
	P150	20884-5	
	P180	20883-8	
	P240	20881-4	

3M™ PSA Cloth Disc 248D (cont.)

Diameter	Grade	UPC (051144-)	Min./Case	
6"	P36	21639-0	50/250	
	P40	21731-1		
	P50	20879-1		
	P60	20878-4		
	P80	20877-7		
	P100	20876-0		
	P120	21497-6		
8"	P36	20874-6		
	P40	20873-9		
	P60	20871-5		
	P80	20870-8		
	P120	20868-5		
12"	P36	88906-8		10
	P40	88905-1		
	P50	88904-4		
	P60	88903-7		
	P80	88902-0		
	P100	88901-3		
16"	P36	88890-0		
	P40	88889-4		
	P60	88887-0		
	P80	88886-3		
18"	P36	88882-5		
	P60	88880-1		
20"	P36	88878-8		
	P40	88877-1		
	P50	88876-4		
	P60	88875-7		
24"	P80	88874-0		
	P36	20802-9		
	P40	20801-2		
	P80	20798-5		

3M™ PSA Discs (cont.)

3M™ PSA Disc 777F

- 3M™ Cubitron™ Abrasive Grain – Polyester Cloth
- Heavy-duty YF-wt. backing provides great strength and flexibility
- Provides long life and fast cut on multiple substrates

Diameter	Grade	UPC (051144-)	Qty./Case
Cloth Backing			
12"	36YF	88869-6	10
	40YF	88873-3	
	50YF	88872-6	
	60YF	88871-9	
	80YF	88870-2	

Accessories — 3M™ PSA Discs

PSA Disc Holder

- Supports 248D PSA disc
- Can be used with any air or electric grinding tool that accommodates a 1/4" shank



Diameter	RPM	UPC (051144-)	Qty./Case
2"	15,000	45070-1	10
3"	10,000	05510-4	
5"	6,000	45068-8	5



3M™ Belt Selection Guide

Belt Product	Application							Metal Type					
	Grinding	Light Grinding	Blending	Deburring	Finishing	Cleaning	Coatings Removal	Stainless Steel	Aluminum	Carbon Steel	Titanium	Nickel Alloy	Non-Ferrous (Brass/Bronze)
241D	●	●	●						●	●			●
241E/ 251E	●								●	●			●
303D					●			●	●	●		●	●
777F	●	●	●	●			●	●	●	●	●	●	●
963G	●	●	●				●	●	●				
977F	●	●					●	●	●	●	●	●	
Trizact 237AA					●		●	●	●		●	●	
Trizact 307EA			●		●		●	●	●		●	●	
Trizact CF			●		●		●	●	●		●	●	
SC			●		●		●	●	●	●	●	●	●
SE			●	●	●		●	●					

Legend:	Mild Steel	Stainless Steel
----------------	-------------------	------------------------

3M™ Backstand, Benchtop and Portable Tool Belts

241D

- Aluminum Oxide – X wt. Cloth
- Excellent all-around abrasive belt for blending and finishing

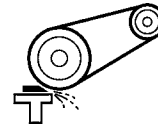

51724

W x L	Grade	UPC (051144-)	Min./Case	
Backstand, Benchtop				
1" x 42"	P36	26614-2	50/200	
	P50	31823-0		
	Grade		UPC (891040-)	Min./Case
	P60	01450-7	25/100	
	P80	01451-4		
	P100	01452-1		
	P120	01453-8		
	Grade		UPC (051144-)	Min./Case
	1-1/2" x 60"	P150	26602-9	50/200
		P180	26601-2	
P240		26599-2		
P320		26597-8		
2" x 48"	P36	26443-8	10/50	
	P40	26441-4		
	P60	26438-4	25/50	
	P80	26436-0		
2" x 60"	P36	26571-8	10/50	
	P50	26568-8		
	P60	26564-0	25/50	
	P80	26562-6		
	P100	26561-9		
	P120	26560-2		
2" x 72"	P50	26424-7	10/50	
	P60	33640-1	25/50	
	P80	33639-5		
	P120	33667-8		
2" x 72"	P36	26320-2	10/50	
	P60	26316-5	25/50	
	P80	33067-6		
	P120	26312-7		
	P180	26309-7		
	P240	81752-8		
2-1/2" x 60"	P36	26408-7	10/50	
	P60	26400-1	25/50	
	P80	26396-7		
	P120	26388-2		

ATTENTION: Belts are available in other grades and sizes. If you don't find the specific belt you need, contact your 3M Sales Specialist or 3M Authorized Distributor.

3M™ Backstand, Benchtop and Portable Tool Belts (cont.)

241D (cont.)

W x L	Grade	UPC (891040-)	Min./Case
Backstand, Benchtop			
6" x 48"	P36	01454-5	10/20
	P40	01455-2	
	P50	01456-9	
	P60	01457-6	
	P80	10454-3	20
	P100	10455-0	
	P120	10456-7	
	Grade	UPC (051144-)	
	P150	26517-6	20
	P180	26515-2	
	P240	26513-8	



241D

W x L	Grade	UPC (051144-)	Min./Case
Portable Tool			
3-1/2" x 15-1/2"	P60	26857-3	10/50
	P80	26856-6	
	Grade	UPC (891040-)	Min./Case
		P120	02663-0

241E/251E

- Grades 50 and finer are 241E
- Grades 40 and coarser are 251E
- Aluminum Oxide – XE wt. Cloth
- High strength backing for tougher applications



W x L	Grade	UPC (051144-)	Min./Case
Portable Tool			
1/4" x 24" 241E	60	26733-0	50/200
	80	26732-3	
1/2" x 12" 241E	60	31170-5	
	80	26894-8	
	120	26892-4	
1/2" x 18" 241E	60	72227-3	
	80	72228-0	
	120	72229-7	
1/2" x 24" 241E/251E	36	32375-3	
	50	26725-5	
	60	26723-1	
	80	26720-0	
	100	26719-4	
	120	26717-0	
3/4" x 18" 241E	180	26715-6	
	60	14756-4	
	80	14519-5	
3/4" x 20-1/2" 241E	120	14667-3	
		26778-1	

303D

- Aluminum Oxide Mineral
- Flexible belt for blending and finishing contoured and complex parts
- Works great for finishing stainless steel



W x L	Grade	UPC (051141-)	Min./Case
Backstand			
2" x 132"	P240	20676-9	25/50
	P280	20675-2	
	P320	20674-5	
	P400	20673-8	
3" x 132"	P240	20680-6	
	P280	20679-0	
	P320	20678-3	
	P400	20677-6	



3M™ Backstand, Benchtop and Portable Tool Belts (cont.)

777F

- 3M™ Cubitron™ Abrasive Grain Blend – YF wt. Cloth
- Contains grinding aid which enhances performance on stainless steel and other exotic alloys
- Can be run wet or dry

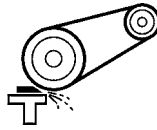

W x L	Grade	UPC (051144-)	Min./Case
Backstand, Benchtop			
1" x 42"	40	76527-0	50/200
	60	77512-5	
	80	14895-0	
1-1/2" x 60"	60	84416-6	25/50
	80	76731-1	
	P120	82022-1	
2" x 48"	36	76738-0	10/50
	60	76519-5	25/50
	80	14896-7	
2" x 60"	36	77663-4	10/50
	60	77152-3	25/50
	80	84296-4	
	P120	85377-9	
2" x 72"	36	76531-7	10/50
	60	80286-9	25/50
	80	14884-4	
	P120	81767-2	
60	82231-7		
2" x 132"	80	14534-8	25/50
	P120	81687-3	
	P180	84315-2	
	36	76532-4	
2-1/2" x 60"	40	77825-6	25/50
	60	76680-2	
	80	76686-4	
	36	76533-1	
3" x 132"	60	76520-1	25/50
	80	76514-0	
	P120	80028-5	
	P180	85762-3	
4" x 132"	80	76515-7	25/50
	P120	81443-5	
6" x 48"	36	82313-0	10/20
	50	80176-3	20
	60	76679-6	
	80	76733-5	
P120	82153-2		

777F



W x L	Grade	UPC (051144-)	Min./Case
Portable Tool			
1/4" x 24"	40	84412-8	50/200
	60	80253-1	
	80	77642-9	
	P120	82229-4	
1/2" x 18"	40	84409-8	
	60	80551-8	
	80	80232-6	
	P120	84304-6	
1/2" x 24"	36	77643-6	
	40	82342-0	
	50	77408-1	
	60	77065-6	
	80	77491-3	
	P120	81064-2	
3/4" x 18"	36	84302-2	
	60	84404-3	
	80	77992-5	
	P120	84303-9	
3/4" x 20-1/2"	60	80486-3	
	80	80686-7	
3-1/2" x 15-1/2"	36	77336-7	10/50
	50	77334-3	
	60	77476-0	
	80	77333-6	
	100	84306-0	
	P120	84307-7	
	P180	85320-5	



14351

ATTENTION: Belts are available in other grades and sizes. If you don't find the specific belt you need, contact your 3M Sales Specialist or 3M Authorized Distributor.

3M™ Backstand, Benchtop and Portable Tool Belts (cont.)

963G ■

- Premium 3M™ Cubitron™ Abrasive Grain – YN wt. Cloth
- Water-resistant polyester cloth backing for heavy grinding
- Can be run wet or dry

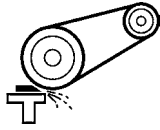

312049

W x L	Grade	UPC (051144-)	Min./Case
Backstand, Benchtop			
2" x 48"	36	14557-7	10/50
	60	13533-2	25/50
	80	13714-5	
2" x 132"	36	74025-3	10/50
	50	11255-5	25/50
	80	11253-1	
3" x 132"	36	74207-3	5/50
	60	74324-7	25/50
	80	13715-2	
4" x 132"	36	74209-7	5/50
	50	74354-4	25/50
	80	74325-4	

977F ■

- 3M™ Cubitron™ Abrasive Grain Blend – YF wt. Cloth
- Recommended for both wet or dry grinding of stainless steel and high nickel alloys
- Works well in all grinding pressures

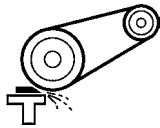

159098

W x L	Grade	UPC (051144-)	Min./Case
Backstand			
2" x 132"	36	83522-5	10/50
	50	85015-0	
	60	85384-7	25/50
	80	85769-2	

3M™ Trizact™ 237AA

- Ideal for metal finishing applications requiring a semi-flexible abrasive
- Resin bonded for heat resistance
- Features a grinding aid for cooler grinding



60872

W x L	Grade	UPC (051111-)	Min./Case
Backstand			
3" x 132"	A100	51213-5	25/50
	A45	51209-8	
	A30	51207-4	
	A16	51199-2	
4" x 132"	A45	51212-8	25/50
	A30	51214-2	
	A16	69017-8	

3M™ Trizact™ 307EA

- Ideal for critical preplate surface finishing
- Flexible rayon cloth backing
- Features grinding aid for cooler grinding

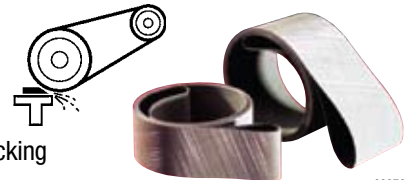

60872

W x L	Grade	UPC (051111-)	Min./Case
Backstand			
2" x 132"	A100	69080-2	25/50
	A80	69077-2	
	A65	69075-8	
	A45	51210-4	
	A30	69068-0	
	A16	51202-9	
3" x 132"	A6	51206-7	25/50
	A80	69078-9	
	A45	69073-4	
	A30	51201-2	
	A16	51200-5	

ATTENTION: Belts are available in other grades and sizes. If you don't find the specific belt you need, contact your 3M Sales Specialist or 3M Authorized Distributor.

3M™ Trizact™ CF 337DC Backstand, Benchtop and Portable Tool Belts (cont.)

3M™ Trizact™ CF 337DC

- Macroreplicated structure provides long product life and consistent cut and finish

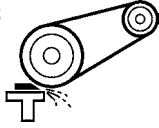

311760

W x L	Grade	UPC (048011-)	Qty./Case
Backstand			
2" x 132"	A300	33162-1	5
	A160	33163-8	
	A100	33164-5	
	A65	33165-2	
	A45	33166-9	
3" x 132"	A300	33167-6	5
	A160	33168-3	
	A100	33169-0	
	A65	33170-6	
	A45	33171-3	



Scotch-Brite™ SE Surface Conditioning Belt

- Coarse, tough, aggressive non-woven belt for heavy duty deburring and finishing
- Reinforced backing offers good flexibility
- Abrasive mineral: coarse grade aluminum oxide
- Color: Brown/blue



W x L	Grade	UPC (048011-)	Qty./Case
Portable			
1/4" x 18"	A CRS	18495-1	20
1/2" x 18"	A CRS	18087-8	20
1/2" x 24"	A CRS	18088-5	20
3/4" x 18"	A CRS	19697-8	20
3-1/2" x 15-1/2"	A CRS	18089-2	10

SCOTCH-BRITE™ BELTS RECOMMENDED OPERATING SPEEDS

Application	Recommended SFPM
Decorative Finishing	500–3,000 SFPM
Deburring	5,000–6,500 SFPM
Cleaning and Conditioning	2,000–5,000 SFPM
Oxide Removal	4,500–6,500 SFPM

Maximum Operating Speed: 6,500 SFPM
SFPM = Surface Feet Per Minute



Scotch-Brite™ Surface Conditioning Belts

- Premium Scotch-Brite™ surface conditioning non-woven web
- Designed for cleaning, finishing and light deburring



159130

W x L	Grade	Color	UPC (048011-)	Min./Case
Portable, Benchtop and Backstand				
1/2" x 18"	A CRS	Brown	08858-7	20
	A MED	Maroon	08857-0	
	A VFN	Blue	08856-3	
1/2" x 24"	A CRS	Brown	05741-5	20
	A MED	Maroon	03998-5	
	A VFN	Blue	04299-2	
3/4" x 18"	A CRS	Brown	13639-4	10
	A MED	Maroon	15899-0	
	A VFN	Blue	14543-3	
1" x 42"	A MED	Maroon	04189-6	10
	A VFN	Blue	04190-2	
2" x 48"	A MED	Maroon	08915-7	10
	A VFN	Blue	04295-4	
2" x 72"	A MED	Maroon	00580-5	5
	A VFN	Blue	00579-9	
2" x 132"	A MED	Maroon	03999-2	5
	A VFN	Blue	04297-8	
2-3/4" x 15-1/2"	A CRS	Brown	05022-5	10
	A MED	Maroon	05227-4	
3" x 10-11/16"	A CRS	Brown	05820-7	10
	A MED	Maroon	05783-5	
	A VFN	Blue	09650-6	
3" x 18"	A MED	Maroon	14285-2	5
	A VFN	Blue	14550-1	
3" x 24"	A CRS	Brown	08880-8	10
	A MED	Maroon	00583-6	
	A VFN	Blue	04298-5	
3" x 132"	A CRS	Brown	05023-2	5
	A MED	Maroon	00568-3	
	A VFN	Blue	04289-3	
3-1/2" x 15-1/2"	A CRS	Brown	05016-4	10
	A MED	Maroon	05228-1	
	A VFN	Blue	05643-2	
6" x 48"	A CRS	Brown	05019-5	5
	A MED	Maroon	00590-4	
	A VFN	Blue	04283-1	

ATTENTION: Belts are available in other grades and sizes. If you don't find the specific belt you need, contact your 3M Sales Specialist or 3M Authorized Distributor.

3M™ Wheel Selection Guide

Wheels	Application				
	Cleaning	Deburring	Blending	Finishing	Polishing
Scotch-Brite™ Unitized Wheels					
Scotch-Brite™ EXL Unitized Deburring Wheels		●	●		●
Scotch-Brite™ Convolute Wheels					
Scotch-Brite™ EXL Deburring Wheels		●	●	●	●
Scotch-Brite™ SF Finishing and Deburring Wheels		●		●	
Scotch-Brite™ Metal Finishing Wheels				●	
Scotch-Brite™ Cut & Polish Wheels			●		
Scotch-Brite™ Multi-Finishing Wheels				●	

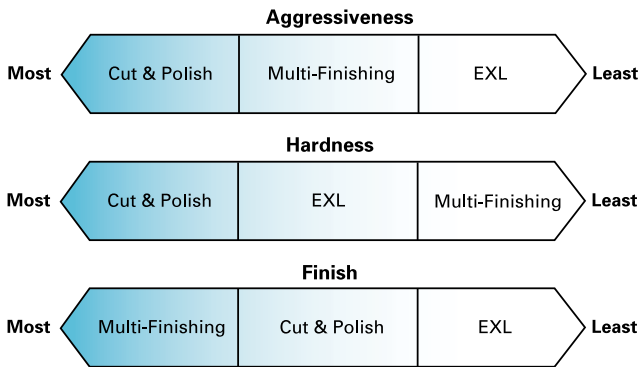

A prefix denotes the mineral in the product (e.g., A FIN):
 A = Aluminum Oxide mineral
 S = Silicon Carbide mineral

When a number appears, this denotes the density of the product (e.g., 2S MED):

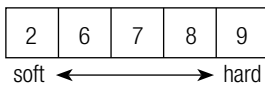

Scotch-Brite™ Unitized Wheels



Scotch-Brite™ EXL Unitized Deburring Wheels

- Excellent for deburring and polishing a wide range of metals, plastics and composites
- Cool running allows more pressure to be applied
- Cleaner than buffs and compounds



51730

Dia. x W x AH	Max. RPM	Grade	UPC (048011-)	Qty./Case
1" x 1" x 3/16"	25,100	2A MED	15527-2	50
	30,100	2S FIN	13713-1	
	35,100	6A MED	14063-6	
		8A MED	13753-7	
		8A CRS	13752-0	
3" x 1/4" x 3/8"	12,100	2A MED	16054-2	40
		2S FIN	14750-5	
	18,100	4A FIN	14751-2	
		6A MED	15118-2	
		8A MED	14753-6	
		8A CRS	13766-7	
6" x 1/2" x 1"	5,000	2S FIN	14379-8	4
	4,500	2A MED	16545-5	
6" x 1" x 1"	5,000	2S FIN	13743-8	2
	4,500	2A MED	16544-8	

For 1", use Mandrel No. 936 or 946
 For 3", use Mandrel No. 990

Accessories — Unitized Wheels

Mandrels

- Designed for use with Scotch-Brite™ Unitized Wheels



Mandrel No. 936



Mandrel No. 990

L x Shaft Dia. x Washer Dia.	Max. RPM	UPC (048011-)	Qty./Case
Mandrel No. 936			
2-1/16" x 1/4" x 3/4"	22,200	04018-9	5
Mandrel No. 990—with 3" wheel			
1-3/4" x 1/4"	18,200	15012-3	5

Scotch-Brite™ Convolute Wheels

Scotch-Brite™ EXL Deburring Wheels

- Use to clean, finish, blend, deburr or polish all types of metals, composites and glass



14497

Dia. x W x AH	Max. RPM	Grade	UPC (048011-)	Qty./Case
6" x 1/2" x 1"	6,000	8A MED	13616-5	4
		8S FIN	09548-6	
		9S FIN	05790-3	
6" x 1" x 1"	6,000	8A MED	13617-2	3
		8S FIN	09549-3	
		9S FIN	05132-1	
8" x 1/2" x 3"	4,500	8A MED	17459-4	4
		8S FIN	14629-4	
		9S FIN	05791-0	
8" x 1" x 3"	4,500	8A MED	13619-6	3
		8S FIN	09551-6	
		9S FIN	05135-2	
8" x 2" x 3"	4,500	8A MED	13620-2	2
		8S FIN	09552-3	
		9S FIN	05136-9	

Scotch-Brite™ SF Finishing and Deburring Wheels

- Use to finish and deburr all types of metals, composites and glass
- Fast, consistent and easy on operators



241317

Dia. x W x AH	Max. RPM	Grade	UPC (048011-)	Qty./Case
6" x 1/2" x 1"	6,000	8S FIN	33174-4	4
		8S MED	33184-3	
6" x 1" x 1"	6,000	8S FIN	33182-9	3
		8S MED	33185-0	



Scotch-Brite™ Metal Finishing Wheels

- Provides a consistent and uniform decorative brushed finish
- Use to match #3 and #4 mil finishes
- Removes minor imperfections and handling marks

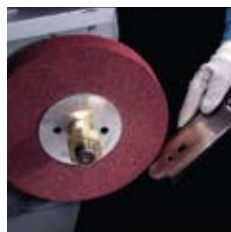

96879

Dia. x W x AH	Max. RPM	Grade	UPC (048011-)	Qty./Case
6" x 1" x 1"	6,000	5A MED	01862-1	3
8" x 1" x 3"	4,500		01871-3	

Scotch-Brite™ Cut & Polish Wheels

- Heavy-duty wheels for aggressive blending and finishing
- Produce uniform results quickly and easily
- Replace rubber bonded wheels, set-up wheels and flap wheels



51737

Dia. x W x AH	Max. RPM	Grade	UPC (048011-)	Qty./Case
6" x 1" x 1"	6,000	7A MED	03262-7	3
		7A FIN	03270-2	



Scotch-Brite™ Multi-Finishing Wheels

- Produces uniform grain finishes on stainless steel and other metals
- Highly conformable



51736

Dia. x W x AH	Max. RPM	Grade	UPC (048011-)	Qty./Case
6" x 1" x 1"	6,000	2S CRS	13170-2	3
		2S MED	13171-9	
		2S FIN	13172-6	
6" x 2" x 1"	6,000	2S CRS	13176-4	2
		2S MED	13177-1	
		2S FIN	13178-8	
8" x 1" x 3"	4,500	2S MED	13183-2	3
		2S FIN	13184-9	
8" x 2" x 3"	4,500	2S CRS	13185-6	2
		2S MED	13186-3	

Accessories — Convolute Wheels

Flange Adapter Kit No. 5

- For use with 6" wheels
- Telescoping wheel adapters 1" and 1/2" wide to reduce 1" wheel cores to fit 1/2", 5/8", 3/4", or 7/8" shafts
- Must be used with side flanges



51738

OD x W x ID	UPC (048011-)	Qty./Case
1" x 1/2" x 1/2"	16859-3	5 Pair
1" x 1" x 1/2"	16860-9	

3M™ Flap Wheels

3M™ Flap Wheels 241E/244E/741A

- Aluminum Oxide – XE wt. Cloth
- General purpose flap wheel delivers consistent finish and uniform cut
- 741A combines aluminum oxide mineral with 3M™ Cubitron™ Abrasive Grain on a strong X-wt. backing



51742

Dia. x W x AH	Max. RPM	Grade	UPC (051144-)	Qty./Case
241E				
6" x 1" x 1"	6,100	100	35111-4	5
244E				
6" x 1" x 1"	6,100	60	35113-8	5
		80	35112-1	
		120	35109-1	
6" x 2" x 1"	5,200	60	35088-9	5
		80	35086-5	
741A				
6" x 1" x 1"	6,100	50	82770-1	5
		60	81986-7	
		80	81984-3	

3M™ Mounted Flap Wheels 244D

- Aluminum Oxide
- General purpose flap wheel delivers consistent finish and uniform cut



T83 – 1/4" Straight



T84 – 1/4" x 20 Threaded

Dia. x W x Shk	Max. RPM	Grade	UPC (051144-)	Qty./Case
T83 – 1/4" Straight				
1" x 1" x 1/4"	30,000	60	35475-7	10
		80	35476-4	
		120	35477-1	
2" x 1" x 1/4"	25,000	60	14623-9	10
		80	14624-6	
		120	14625-3	
3" x 1" x 1/4"	20,000	60	14655-0	10
		80	14656-7	
		120	14657-4	
T84 – 1/4" x 20 Threaded				
1" x 1" x 1/4"-20	30,000	60	35467-2	10
		80	35468-9	
		120	35469-6	
2" x 1" x 1/4"-20	25,000	60	14575-1	10
		80	14576-8	
3" x 1" x 1/4"-20	20,000	60	14607-9	10
		80	14608-6	

3M™ Cloth Flap Wheels 747D

- 3M™ Cubitron™ Abrasive Grain blend on a resin-bonded X-wt. cloth backing
- Includes a grinding aid for cooler running on stainless steel



T83 – 1/4" Straight



T84 – 1/4" x 20 Threaded

Dia. x W x Shk	Max. RPM	Grade	UPC (051144-)	Qty./Case
T83 – 1/4" Straight				
1" x 1" x 1/4"	30,000	60	80761-1	10
		80	80757-4	
		P120	80753-6	
2" x 1" x 1/4"	25,000	60	80763-5	10
		80	80759-8	
		P120	80755-0	
3" x 1" x 1/4"	20,000	60	80650-8	10
		80	80651-5	
		P120	80652-2	
T84 – 1/4" x 20 Threaded				
2" x 1" x 1/4"	25,000	60	83271-2	10
		80	83268-2	
		P120	83265-1	
3" x 1" x 1/4"	20,000	60	83269-9	10
		80	83267-5	
		P120	83263-7	

Accessories — Flap Wheels

Wheel Adapter Kit No. 3

- Two arbor hole (plug type) adapters for 6" and 8" diameter flap wheels
- 1" O.D. x various I.D.'s



ID	UPC (051144-)	Qty./Case
1/2"	45035-0	5
5/8"	45034-3	
3/4"	45033-6	
7/8"	45032-9	

51741



Bench Area Products

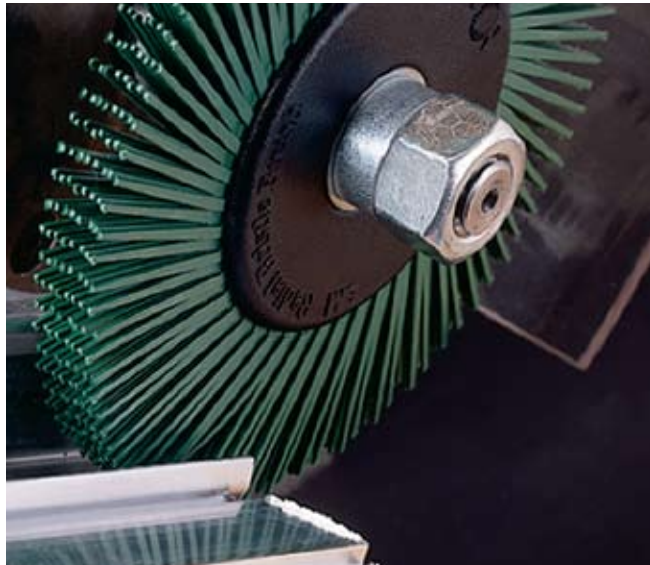

179577



Scotch-Brite™ Radial Bristle Brush, TA

- Excellent replacement for wire brushes
- Use on bench motors for general purpose cleaning applications
- No flying wires yet higher cut rates
- Very strong and flexible
- Comes with adapters for multiple shaft sizes (1/2", 5/8", 3/4", 7/8", 1" and 2")



159129

Dia. x W	Max. RPM	Grade	Color	UPC (048011-)	Qty./Case
6" x 1/2"	6,000	36	Dark Brown	27603-8	5
		50	Green	27605-2	
		80	Yellow	27606-9	

Scotch-Brite™ Stars

- Perfect for polishing internal diameters of pipe and tubing
- Conformable Scotch-Brite™ construction assures complete cleaning and polishing of all surfaces

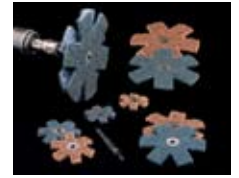

51751

Diameter	Max. RPM	Grade	UPC (048011-)	Qty./Case
1-1/2"	24,000	A VFN	13800-8	100
		A CRS	13370-6	
2"		A VFN	13803-9	
		A CRS	13371-3	
3"	18,000	A VFN	13802-2	50
		A CRS	13372-0	
4"		A VFN	13804-6	
		A CRS	13373-7	

Scotch-Brite™ Flap Brush CPFB-S and CPFB-R

- Heavy-duty brush
- Excellent for removing handling marks and surface imperfections
- Available on 1/4" shaft (CPFB-S) or 3M™ Roloc™+ attachment system (CPFB-R)



51748

Dia. x W x (Shaft)	Max. RPM	Grade	UPC (048011-)	Qty./Case
CPFB-S				
2" x 1" x 1/4"	12,000	A MED	16622-3	25
3" x 1-3/4" x 1/4"	8,500		05974-7	10
CPFB-R				
3" x 1-3/8"	8,000	A MED	14588-4	10

Scotch-Brite™ Flap Brush CFFB-S and CFFB-R

- Ideal for decorative finishes and light deburring applications
- Available on 1/4" shaft (CFFB-S) or 3M™ Roloc™+ attachment system (CFFB-R)



160008

Dia. x W x (Shaft)	Max. RPM	Grade	UPC (048011-)	Qty./Case
CFFB-S				
3" x 1-3/4" x 1/4"	8,500	A CRS	05975-4	10
		S FIN	14781-9	
CFFB-R				
3" x 1-3/8"	8,000	A CRS	14587-7	10
		S FIN	14783-3	

Bench Area Products (cont.)

Scotch-Brite™ Combi Wheel, Combi-S

- Made of alternating flaps of coated abrasive and Scotch-Brite™ web
- Provides aggressive cut and fine finishes



51752

Dia. x W x Shaft	Max. RPM	Grade	UPC (051144-)	Qty./Case
CFFB-S				
3" x 1-3/4" x 1/4"	8,000	80	80801-4	10
		P120	80678-2	
		P180	80799-4	

Scotch-Brite™ Clean & Strip Discs CSD2-S

- Aggressive web is excellent for cleaning welds, rust, paint and coatings



51747

Dia. x W x Shaft	Max. RPM	Grade	UPC (048011-)	Qty./Case
CSD2-S				
4" x 1" x 1/4"	8,000	S XCS	14780-2	10

Scotch-Brite™ CPD5-R and CPD5-S Discs

- Five discs made of a durable web, ganged together on a shaft
- Use for satin or antique finishing as well as light- to medium-duty cleaning applications
- Choose from either 3M™ Roloc™+ or a 1/4" spindle mount attachment system



159131

Dia. x W x (Shaft)	Max. RPM	Grade	UPC (048011-)	Qty./Case
CPD5-R				
3" x 1-1/4"	10,000	A MED	14594-5	10
4" x 1-1/4"	8,000		14590-7	
CPD5-S				
3" x 1-1/4" x 1/4"	10,000	A MED	14593-8	10
4" x 1-1/4" x 1/4"	8,000		14779-6	

Accessories — Bench Area Products

Mandrel No. 944

- Use in conjunction with Scotch-Brite™ Stars for cleaning and polishing internal diameters of pipe and tubing



51746

Shank x Thread	Max. RPM	UPC (048011-)	Qty./Case
1/4" x 1/4"-20 EXT	25,100	13928-9	10

3M™ Roloc™+ Holder No.1

- For use with 3M™ Roloc™+ products

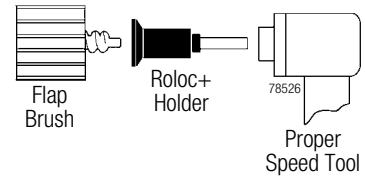

L x Dia.	UPC (048011-)	Qty./Case
1" x 1/4"	15408-4	5



51752

3M™ Cartridge Rolls



14379

3M™ Cartridge Rolls 241D

- Aluminum Oxide – X wt. Cloth
- General purpose cartridge rolls



51754

Dia. x L x CH	Max. RPM	Grade	UPC (051144-)	Qty./Case
Regular				
1/4" x 1" x 1/8"	24,000	P60	96959-3	100
		P80	14021-3	
		P120	96961-6	
		P180	96963-0	
1/4" x 1-1/2" x 1/8"	24,000	P60	96968-5	100
		P80	96969-2	
		P120	96971-5	
		P180	96973-9	
3/8" x 1" x 1/8"	24,000	P60	14024-4	100
		P80	14023-7	
		P120	14022-0	
		P180	97008-7	
3/8" x 1-1/2" x 1/8"	24,000	P60	97013-1	100
		P120	97015-5	
		P180	97017-9	
		P60	97041-4	
1/2" x 1" x 1/8"	24,000	P80	97042-1	100
		P120	97044-5	
		P60	14028-2	
		P80	14027-5	
1/2" x 1-1/2" x 1/8"	24,000	P120	14026-8	100
		P180	97059-9	
		P60	97162-6	
		P80	97163-3	
3/4" x 1-1/2" x 3/16"	16,000	P120	97165-7	100

3M™ Cartridge Rolls 241D (cont.)

Dia. x L x CH	Max. RPM	Grade	UPC (051144-)	Qty./Case
Full Taper				
3/8" x 1" x 1/8"	24,000	P60	97239-5	100
		P80	97240-1	
		P120	97242-5	
		P180	97244-9	
3/8" x 1-1/2" x 1/8"	24,000	P60	97248-7	100
		P80	97249-4	
		P120	97251-7	
		P60	97257-9	
1/2" x 1" x 1/8"	24,000	P120	97259-3	100
		P60	14034-3	
1/2" x 1-1/2" x 1/8"	24,000	P80	14033-6	100
		P120	14032-9	
		P180	97267-8	

3M™ Cartridge Rolls 747D

- 3M™ Cubitron™ Abrasive Grain – X wt. Cloth
- Resin bond cloth for heat resistance
- Features grinding aid for cooler grinding



14378

Dia. x L x CH	Max. RPM	Grade	UPC (051144-)	Qty./Case
Regular				
1/2" x 1-1/2" x 1/8"	24,000	60	80790-1	100
		80	80796-3	
		P120	80792-5	
Full Taper				
1/2" x 1-1/2" x 1/8"	24,000	60	80786-4	100
		80	80787-1	
		P120	80788-8	

Accessories — 3M™ Cartridge Rolls

3M™ Mandrels

- Screw-type mandrels for securing cartridge rolls to tool
- Match pilot diameter with center hole of cartridge rolls



51755

Pilot Dia. x Pilot Length x Shank	UPC (051144-)	Qty./Case
1/8" x 1" x 1/4"	45119-7	25
3/16" x 1" x 1/4"	45117-3	
3/16" x 1-1/2" x 1/4"	45118-0	
Max RPMs: 24,000 for 1/2" and smaller cartridge roll diameter 16,000 for 5/8"– 3/4" cartridge roll diameter		

3M™ Evenrun Bands

3M™ Evenrun Bands 241D

- Aluminum Oxide – X wt. Cloth
- General purpose evenrun bands



51756

Dia. x W	Max. RPM	Grade	UPC (051144-)	Qty./Case
1/4" x 1/2"	23,000	P80	40243-4	100
		P120	97428-3	
1/2" x 1/2"	30,000	P60	40228-1	
		P80	40227-4	
		P120	40252-6	
1/2" x 1"	15,000	P36	97458-0	
		P60	40225-0	
		P80	40224-3	
		P120	11973-8	
3/4" x 1"	17,000	P36	11976-9	
		P60	40221-2	
		P80	40220-5	
		P120	40219-9	
3/4" x 1-1/2"	10,000	P36	11977-6	
		P80	40241-0	
1" x 1"	18,000	P36	40214-4	
		P60	40211-3	
		P80	40210-6	
		P120	40208-3	
1" x 1-1/2"	10,000	P36	40207-6	
		P60	11980-6	
1-1/2" x 1"	14,000	P80	40205-2	
		P36	40203-8	
1-1/2" x 1-1/2"	10,000	P60	40202-1	
		P36	40200-7	
1-1/2" x 2"	8,000	P60	40197-0	
		P80	40196-3	
		P120	40274-8	
2" x 1"	12,000	P60	40267-0	
		P60	40192-5	
2" x 2"	6,000	P36	40187-1	
		P60	40184-0	
		P80	40183-3	
3" x 3"	3,000	P36	40178-9	
		P60	40175-8	
		P80	40174-1	
		P120	40172-7	

3M™ Evenrun Bands 747D

- 3M™ Cubitron™ Abrasive Grain – X wt. Cloth
- Resin bonded cloth for heat resistance
- Features grinding aid for cooler running

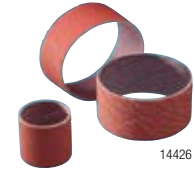

14426

Dia. x W	Max. RPM	Grade	UPC (051144-)	Qty./Case
1/2" x 1"	15,000	50	80765-9	100
		60	80769-7	
		80	80773-4	
1" x 1"	18,000	50	80766-6	
		60	80770-3	
		80	80774-1	
		P120	80782-6	
2" x 1"	11,000	60	80771-0	
		80	80775-8	
		P120	80783-3	

Accessories — Evenrun Bands

Rubber Slotted Expander Wheels

- Slotted wheels for use with evenrun bands



51757

Dia. x W x Shaft	Max. RPM	UPC (051144-)	Qty./Case
1" x 1" x 1/4"	18,000	77717-4	1
1-1/2" x 1" x 1/4"	14,000	77718-1	
2" x 1" x 1/4"	12,000	77720-4	
2" x 2" x 1/4"	6,000	77721-1	
3" x 3" x 5/8"-INT		77722-8	

Rubber Cushion Polishing Wheels

- Use with evenrun bands when creating fine finishes
- Part numbers apply to complete wheel, not cushions



51758

Dia. x W x Shaft	Max. RPM	UPC (051144-)	Qty./Case
1/4" x 1/2" x 1/8"	23,000	45159-3	10
1/2" x 1/2" x 1/4"	30,000	45156-2	
1/2" x 1" x 1/4"	15,000	45153-1	
1/2" x 1-1/2" x 1/4"		45152-4	
3/4" x 1" x 1/4"	17,000	45145-6	
3/4" x 1-1/2" x 1/4"	10,000	45144-9	
1" x 1" x 1/4"	18,000	45139-5	
1" x 1-1/2" x 1/4"	10,000	45138-8	
1-1/2" x 1" x 1/4"	14,000	45132-6	
1-1/2" x 1-1/2" x 1/4"	10,000	45131-9	
1-1/2" x 2" x 1/4"	8,000	45130-2	
2" x 1" x 1/4"	11,000	45129-6	
2" x 2" x 1/4"	6,000	45127-2	
3" x 3" x 3/8"	3,000	45124-1	
3" x 3" x 1/2"		45123-4	

3M™ Utility Cloth Sheet and Roll Selection Guide

Hand Sanding Product	Application		
	Blending	Finishing	Cleaning
Aluminum Oxide Mineral			
314D • Ideal for utility jobs • Durable cloth backing	●	●	●
211K • Flexible • Use for all general maintenance work		●	
Emery			
011K • Closed Coat • General purpose	●	●	

Utility Cloth Sheets and Rolls

3M™ Utility Cloth Sheets and Rolls 314D

- Aluminum Oxide – X and J wt. Cloth
- Constructed on a durable cloth backing
- Ideal for all utility jobs
- Can be torn into strips and rolled without shelling



W x L	Backing	Grade	UPC (051115-)	Min./Case
Sheets				
9" x 11"	X wt.	P40	19775-8	50/250
		P50	19774-1	
		P60	19773-4	
	J wt.	P80	19772-7	
		P100	19771-0	
		P120	19770-3	
		P150	19769-7	
		P180	19768-0	
		P220	19767-3	
		P240	19766-6	
		P280	19765-9	
		P320	19764-2	
		P400	19763-5	

3M™ Utility Cloth Sheets and Rolls 314D (cont.)



406561

W x L	Backing	Grade	UPC (051115-)	Min./Case
Utility Rolls				
1" x 50 yds.	X wt.	P50	19794-9	1/5
		P60	19793-2	
	J wt.	P80	19792-5	
		P100	19791-8	
		P120	19790-1	
		P150	19789-5	
		P180	19788-8	
		P220	19787-1	
		P240	19786-4	
		P280	19785-7	
		P320	19784-0	
		P400	19783-3	
		1-1/2" x 50 yds.	X wt.	
P60	19812-0			
1-1/2" x 50 yds.	J wt.	P80	19811-3	
		P100	19810-6	
		P120	19809-0	
		P150	19808-3	
		P180	19807-6	
		P220	19806-9	
		P240	19805-2	
		P280	19804-5	
		P320	19803-8	
		P400	19802-1	
		2" x 50 yds.	X wt.	P40
P50	19825-0			
P60	19824-3			
J wt.	P80		19823-6	
	P100		19822-9	
	P120		19821-2	
	P150		19820-5	
	P180		19819-9	
	P220		19818-2	
	P240		19817-5	
	P280		19816-8	
	P320		19815-1	
	P400		19814-4	

Utility Cloth Sheets and Rolls (cont.)

3M™ Portable Utility Roll 314D

- Portable for ease of use at jobsite
- Protective plastic pack resists dirt, oil, water and serves as a convenient dispenser
- Aluminum oxide abrasive product sheets constructed on X- or J-weight, durable cloth backing



W x L	Grade	UPC (051141-)	Qty./Case
1" x 8 yds.	P60 X	20963-5	1/5
1" x 12 yds.	P80 J	20964-2	
1" x 16 yds.	P120 J	20965-9	
1" x 20 yds.	P180 J	20966-6	
	P240 J	20967-3	
1" Portable Utility Roll Kit			
Kit contains one (1) each of the above utility rolls		20968-0	1/5

3M™ Utility Cloth Sheets and Rolls 211K

- Aluminum Oxide – J wt. Cloth
- Use these flexible utility rolls and sheets for general applications such as deburring, rust removal, strapping and all general maintenance work

W x L	Grade	UPC (051144-)	Min./Case
Sheets			
9" x 11"	320	02402-5	50/250
	400	12501-2	
	500	12500-5	
Utility Rolls			
1" x 50 yds.	320	05002-4	1/5
	400	05001-7	
	500	05000-0	
1-1/2" x 50 yds.	320	05022-2	
	400	05021-5	
	500	05020-8	
2" x 50 yds.	320	05042-0	
	400	05041-3	
	500	05040-6	

3M™ Utility Cloth Sheets 011K

- Emery Cloth – Closed Coat
- General purpose use



W x L	Grade	UPC (051144-)	Min./Case
Sheets			
9" x 11"	CRS	02433-9	50/250
	MED	02432-2	
	FINE	02431-5	

Accessories — Utility Cloth Sheets and Rolls

Forked Spindle

- For attaching utility cloth strips



Dia. x L	UPC (051144-)	Qty./Case
1/4" x 3"	45121-0	10

3M™ Wetordry™ Sheet Selection Guide

Hand Sanding Product	Application	
	Blending	Finishing
Silicon Carbide		
431Q • Reduced clogging, eliminates dust • Heavy wt. paper for increased durability	●	
413Q • Reduced clogging, eliminates dust • Excellent conformability		●

3M™ Paper Sheet Selection Guide

Hand Sanding Product	Application	
	Blending	Finishing
Aluminum Oxide		
346U • Hand or machine sanding of many different materials	●	
336U • General purpose sanding for soft materials	●	
210N • Exceptional conformability for contour sanding		●

3M™ Wetordry™ Sheets

3M™ Wetordry™ construction reduces clogging, helps eliminate dust, extends abrasive life and improves finish.

3M™ Wetordry™ Paper Sheets 431Q

- Silicon Carbide – C wt. Paper
- Heavyweight paper backing for increased durability



W x L	Grade	UPC (051144-)	Min./Case
9" x 11"	80	02018-8	50/250
	100	02017-1	
	120	02016-4	
	150	02015-7	
	180	02014-0	

3M™ Wetordry™ Sheets 413Q

- Silicon Carbide – A wt. Paper
- Excellent conformability



W x L	Grade	UPC (051144-)	Min./Case
9" x 11"	220	02007-2	50/500
	240	02006-5	50/250
	280	02005-8	
	320	02004-1	50/500
	360	02003-4	50/250
	400	02002-7	50/500

3M™ Paper Sheets

3M™ Paper Sheets 346U

- Aluminum Oxide – D wt. Paper
- Ideal for hand or machine sanding of many different materials, including woods, metals, paints, plastics and fiberglass



W x L	Grade	UPC (051144-)	Min./Case
9" x 11"	36	02119-2	50/250
	40	02118-5	
	50	02117-8	50/500
	60	02116-1	
	80	02115-4	

3M™ Paper Sheets 336U

- Aluminum Oxide – C wt. Paper
- Medium-weight sheets for general-purpose sanding
- Open coat resists loading on soft materials



W x L	Grade	UPC (051144-)	Min./Case
9" x 11"	100	02114-7	100/1000
	120	02113-0	
	150	02112-3	

3M™ Paper Sheets 210N

- Aluminum Oxide – A wt. Paper
- Open Coat
- Provides exceptional conformability for contour sanding

W x L	Grade	UPC (051144-)	Min./Case
9" x 11"	180	02104-8	100/1000
	220	02103-1	

Scotch-Brite™ Hand Pad, Sheet Roll and Roll Selection Guide

Hand Sanding Product	Application			
	Blending	Finishing	Deburring	Cleaning
Scotch-Brite™ Hand Pad 7440 <ul style="list-style-type: none"> Durable Ideal for tough blending and finishing applications 	●	●	●	
Scotch-Brite™ Hand Pad 7446 <ul style="list-style-type: none"> Conformable Ideal for general blending, finishing, and light deburring 	●	●	●	
Scotch-Brite™ Hand Pad 7447 <ul style="list-style-type: none"> Conformable Ideal for general blending, finishing, and cleaning as well as paint prep 	●	●		●
Scotch-Brite™ Hand Pad 7448 <ul style="list-style-type: none"> Conformable Ideal for finishing and blending 	●	●		●
Scotch-Brite™ Multi-Flex <ul style="list-style-type: none"> Highly conformable Excellent sharpness 	●	●		●
Scotch-Brite™ Cut & Polish <ul style="list-style-type: none"> Heavy-duty for tough blending and finishing jobs Can be cut to desired length 	●	●	●	
Scotch-Brite™ Clean & Finish <ul style="list-style-type: none"> Conformable General purpose use Can be cut to desired length for hand sanding or oscillating sanders 	●	●	●	●

Scotch-Brite™ Hand Pads



Scotch-Brite™ Hand Pads

- Excellent products for hand finishing and cleaning of woods, metals and composites
- Ideal for wood finishing, paint prep and general cleaning



W x L	Cat. No.	Color	Grade	UPC (048011-)	Qty./Case
6" x 9"	7440	Tan	A MED	04050-9	40
	7446	Gray	S MED	04051-6	
	7447 Bulk	Maroon	A VFN	04029-5	60
	7448			Light Gray	

Scotch-Brite™ Hand Pad Trial Pack 961S

Kit contains: 1 ea. Scrubbing Sponge 74, Light Duty Pad 6448, Heavy Duty Pad 7440, Light Duty Cleansing Pad 7445, Blending Pad 7446, General Purpose Pad 7447, Ultra Fine Pad 7448, Production Pad 8447, Twist-Lok Pad Holder 961



UPC (048011-)	Min./Case
17144-9	5

Accessories — Scotch-Brite™ Hand Pads

Scotch-Brite™ Pad Holder No. 961

- Use with Scotch-Brite™ hand pads
- Provides increased leverage and eliminates "finger" marks



W x L	UPC (048011-)	Qty./Case
3-1/2" x 4-3/4"	09493-4	10

Scotch-Brite™ Rolls

Scotch-Brite™ Multi-Flex Sheet Rolls

- Highly conformable non-woven web roll is perforated to easily tear into sixty 8" x 4" sheets
- Excellent sharpness and conformability for cleaning and finishing surfaces by hand



51768

W x L	Color	Grade	UPC (051131-)	Min./Case
8" x 20'	Maroon	A VFN	07521-4	1/4
	Light Gray	S ULF	07522-1	

Scotch-Brite™ Cut & Polish Rolls

- A unique and aggressive material for cleaning and finishing
- Sturdy, long lasting web material is great for heavy industrial cleaning and light deburring applications
- Works well for stropping and other bench applications



14432

W x L	Grade	UPC (048011-)	Qty./Case
1" x 30'	A MED	04085-1	12
2" x 30'		05206-9	6
4" x 30'		05207-6	3

Scotch-Brite™ Clean & Finish Rolls

- Highly conformable Scotch-Brite™ web can be cut to desired length for hand sanding or oscillating sanders



51764

W x L	Grade	UPC (048011-)	Min./Case
4" x 30'	A MED	00264-4	1/3
	A FIN	00265-1	
	A VFN	00266-8	
	S VFN	00270-5	
6" x 30'	A MED	00274-3	1/2
	A FIN	00275-0	
	A VFN	00276-7	

Accessories — Scotch-Brite™ Rolls

Mini Mandrel No. 935

- Use with desired Scotch-Brite™ strips to clean and polish inner diameters and other tight areas
- Has a 1/4" shank to fit desired tool



14475

L x Dia.	Max. RPM	UPC (048011-)	Qty./Case
2-7/8" x 1/4"	14,000	04020-2	5

3M™ Intro Kits

An easy way to evaluate the right product, size and grade for your application.



Scotch-Brite™ Surface Conditioning Disc Pack 920S

- Contains a variety of grades of 2" and 3" non-woven surface conditioning discs
- Used for cleaning, finishing, blending and deburring applications
- Includes 922 and 923 disc pad holder

Size	UPC (048011-)	Min./Case
2" and 3"	18253-7	1/5

3M™ Roloc™ Bristle Disc Pack 983BS

- Contains a variety of grades of Roloc™ Bristle Discs 3" diameter x 5/8" trim
- Includes a disc pad holder



Size	UPC (048011-)	Min./Case
3"	18697-9	1/5

Scotch-Brite™ Surface Conditioning Disc Pack 914S, 9145S, 915S, 917S

- Contains a variety of grades of non-woven surface conditioning discs
- Used for cleaning, finishing, blending and deburring applications
- Includes 9145 disc pad holder



Disc Product	Size	Max RPM	UPC (048011-)	Min./Case
914S	4"	13,000	08707-8	1/5
9145S	4-1/2"	13,000	14105-3	1/5
915S	5"	10,000	08713-9	1/5
917S	7"	6,000	04270-1	1/5

3M™ Roloc™ Disc Pack 9815S, 982S, 983S, 984WS

- 9815S, 982S, 983S each include: Roloc™ Surface Conditioning Discs, 3M™ Coated Abrasive Discs and 3M™ Roloc™ Disc Pad
- 984WS includes: 4 Roloc™ 984C Regal™ Resin Bond Fibre Discs; 3 Roloc™ Surface Conditioning Discs; 1 Roloc™ SE Surface Conditioning Disc; 1 Roloc™ Disc Pad



Disc Product	Size	UPC (051144-)	Min./Case
9815S	1-1/2"	82901-9	1/5
982S	2"	82899-9	1/5
983S	3"	82900-2	1/5
984WS	4"	83490-7	1/5

3M™ Roloc™ Disc Pack 985S

- Contains a variety of grades of 2" and 3" non-woven 3M™ Roloc™ Surface Conditioning Discs
- Also contains 2" and 3" disc pads and 1/4" threaded shaft



Size	UPC (048011-)	Min./Case
2" and 3"	18254-4	1/5

Scotch-Brite™ Unitized Wheel Pack 990S

- Contains several Scotch-Brite™ external Unitized Wheels 1" x 1" x 3/16" and 3" x 1/4" x 3/8" in a variety of densities and grades
- Also includes 936 and 990 mandrels



Size	UPC (048011-)	Min./Case
1" x 1" x 3/16" and 3" x 1/4" x 3/8"	18245-2	1/5

3M™ NTN Maintenance and Repair Kit

- Variety of easy mounting (no mounting tools required) coated and surface conditioning 4-1/2" discs for use on right angle tools
- Components:
 - 1 – 3M™ TN Disc Pad
 - 1 – Scotch-Brite™ Light Grinding and Blending Disc, TN, Super Duty
 - 1 – Scotch-Brite™ Clean and Strip XT Disc, TN, S-XCS
 - 1 – 3M™ Fibre Disc 785C, TN, grade 36
 - 1 – 3M™ Flap Disc 747D, TN, grade 36



Size	UPC (048011-)	Min./Case
4-1/2"	33013-6	1/5

Abrasive Grade Comparison Guide

Ind'l Mesh-ANSI	FEPA "P"	Trizact™	Micron (μ)	Scotch-Brite™ Grade*
12				
	P12			
	P16			
16				
	P20			
20				
	P24			
24				
	P30			
30				
36				
	P36			
40				
	P40			
50		A500		
	P50			
60		A400		
	P60			
	P80	A300		
80			180	
	P100	A200	150	
100				Extra Coarse
	P120	A160	120	
120				Coarse
			100	
	P150	A130		
150		A110		Medium
180	P180	A100	80	
220				
	P220	A90		
		A80	60	
	P240	A75		
240		A65		Fine
	P280			
		A60	50	
	P320			
280			40	
	P360			
320				Very Fine
	P400	A45	35	
	P500		30	
360				
400	P600	A30		
	P800	A25	22	
			20	
500				
	P1000	A20	18	
600				Super Fine
	P1200	A16		
			15	
	P1500	A10		
800			12	
	P2000		10	
1000				Ultra Fine
			9	
	P2500			
		A7		
1200		A6		
		A5	5	Microfine
1500		A3	3	
2000			1	

Scotch-Brite™ Disc Grade Guide

Density Number (prefix to mineral)

soft ←————→ hard

2	4	6	7	8	9
---	---	---	---	---	---

Mineral Abbreviations (prefix to grade)

A—Aluminum Oxide mineral
 S—Silicon Carbide mineral
 T—Talc mineral

Grade Abbreviations

ULF—Ultra Fine
 SFN—Super Fine
 VFN—Very Fine
 FIN—Fine
 MED—Medium
 CRS—Coarse
 XCS—Extra Coarse

Example:

2S MED = Soft Density, Silicon Carbide Mineral, Medium Grade

2S MED

Soft Density | Medium Grade

Silicon Carbide Mineral

Measurement Conversions:
 1 inch = 25.4 millimeters
 1 millimeter = 0.039370 inches
 1 micron (μ) = 0.000039 inches

ANSI—American National Standards Institute

FEPA—Federation of European Producers of Abrasives Products

*Scotch-Brite™ Surface Conditioning Grade (Generates finish approximately equivalent to indicated coated abrasive grade.)

Adhesive Selection Guide

	Structural Adhesives: Each adhesive has high cohesive strength to bond high strength materials and potentially replace mechanical fasteners.		Non-Structural Adhesives	
Metal to:	3M™ Scotch-Weld™ Epoxy, Acrylic Adhesives	3M™ Scotch-Weld™ Instant Adhesives	3M™ Scotch-Grip™** Adhesives	3M™ Aerosol Adhesives
Metal	Acrylics, Epoxies	CA40H	1357, 1099 (All), 1300	80, 90
EPDM Rubber	—	CA40H	4799	—
Rubber (except EPDM)	Flexible 2-part Epoxies	CA40H	1300, 847	80, 90*
Glass and Ceramics	Flexible 2-part Epoxies	—	1357	80, 90
Leather	Flexible 2-part Epoxies	—	847	80
Plastics (Polyolefins)	DP8005	—	—	90
Plastics (ABS, PVC, Acrylic, etc.)	DP8005	CA40H	1357	77, 80, 90
Plastics (High Performance Nylon)	DP460	CA40H	1099 (All)	77, 80, 90
Plastics (Flexible Vinyl)	Flexible 2-part Epoxies	CA40H	1099 (All)	80
Paper and Cardboard	2-part Epoxies	—	10	77
Fabric, Felt, Cork and Fibrous Glass	2-part Epoxies	—	—	74, 77, 80, 90
Flexible Foam (Latex, Urethane)	—	—	—	74, 90
Rigid Foam (Beadboard, Styrene)	Flexible 2-part Epoxies	—	—	—
Rigid Foam (Urethane)	Flexible 2-part Epoxies	CA40H	1357, 5, 10	74, 80

Note: The technical information and data on these pages should be considered representative or typical only and should not be used for specification purposes. Final product selection should be made only after consideration of a variety of factors and evaluations of sample bonds.

*Produces a temporary bond on these materials. (1) Adhesives must be force dried and bonded while warm. (2) For best results, preheat the substrate to a minimum of 120°F (49°C). (3) Evaluate usage surface activator.





**3M™ Scotch-Grip™ Adhesives will be rebranded 3M™ Scotch-Weld™ Adhesives in 2007.

3M™ Non-Structural Adhesives



3M™ Aerosol Adhesives

Only a finger's touch puts a job-matched formulation to work on paper, plastic, cardboard, foam, metal and more. 3M Aerosol Adhesives contain no methylene chloride, chlorofluorocarbons (CFCs), or 1,1,1-trichloroethane (methyl chloroform) and are California compliant.

Product Number/Description	Spray Width	Bonding Range Surfaces One/Both	(PSI) Shear ¹ Initial/Ultimate	Relative Adhesion		Coverage Sq. Ft/ Container ⁴ (Typical)	Color	Size	UPC (021200-)	Qty./ Case
				Peel Strength (PIW) ²	Temperature Resistant ³					
3M™ FoamFast 74 Spray Adhesive										
 <ul style="list-style-type: none"> • Fast tack with foam-tearing strength • Soft, non-dimpling glue line • General upholstery foam bonding • Knife edge bonding, boxing, edge turning • Bonds flexible urethane or latex foam together or to wood, metal and plastic 	1" – 4" variable	N/R/ 15 min.	40/205	20	120°F (49°C)	260	Orange	24 fl. oz. can	82242-1	12
							Clear		50045-9	
							Original Formula Orange		96316-2*	
3M™ Super 77 Multipurpose Spray Adhesive										
 <ul style="list-style-type: none"> • Fast, aggressive tack for bonding many lightweight materials • High coverage • Low soak-in for long lasting bonds • Bonds gaskets in water pumps, and attaches insulation to sheet metal 	1-1/2" – 4" fan	15 min./ 30 min.	25/160	15	110°F (43°C)	220	Original Formula	24 fl. oz. can	96315-5*	12
							Low Mist		21210-9	
3M™ Rubber & Vinyl 80 Spray Adhesive										
 <ul style="list-style-type: none"> • Neoprene-based contact adhesive with plasticizer resistance • Adheres stainless steel panels, stiffeners, metal kick plates, leather and most supported vinyl, plastics, laminates, wood products and rubbers (except EPDM) 	3"	N/R/ 1 hr.	50/400	35	200°F (93°C)	75/30 ⁴	—	24 fl. oz. can	82618-4	6
3M™ Hi-Strength 90 Spray Adhesive										
 <ul style="list-style-type: none"> • High contact bond for decorative laminate • Adheres to polyethylene and polypropylene to wood, metal and more • One minute dry time 	1" – 4" variable	N/R/ 15 min.	45/230	25	160°F (71°C)	100	—	24 fl. oz. can	30023-3	12

1 ATD T.M. C-700: 1/8" birch veneer bonded to 1/8" birch veneer

2 ATD T.M. C-449

3 ATD T.M. C-483: 500 g load for 1 hr. at noted temperature

4 Plastic laminate bonding @ 3-5 g/sq. ft. coverage

5 Coverage based on container sizes 24 fluid ounce or 16 fluid ounce size cans





N/R = Not Recommended

* NOT FOR SALE IN CALIFORNIA

Adhesives

3M™ Non-Structural Adhesives (cont.)

3M™ Scotch-Grip™* Plastic Adhesives: The Scotch-Grip™ Adhesive is a tool designed adhesive designed to provide innovative answers to a wide variety of non-structural bonding problems.

Product Number/Description	Solids Weight (Approx.)	Flash Point (Closed Cup)	Consistency	Color Dry Film	Application Method	Bonding Range	Overlap Shear Strength (PSI)		Peel Strength (PSI)	Size	UPC (021200-)	Qty./Case
							75°F (24°C)	180°F (82°C)	75°F (24°C)			
3M™ Scotch-Grip™ Plastic Adhesives												
1099												
<ul style="list-style-type: none"> • Fast drying and heat curable • Resists weathering, water, oil, plasticizer migration, aliphatic fuels • Meets MIL-A-13883B, Type 1 and MMM-A-189C, Class 2 • A very strong plastic adhesive • Bonds most plastic and vinyl 												
	32%	0°F (-18°C)	Medium Liquid	Light Tan	Brush, Flow	Up to 40 min.	1306 ^{1,2}	643 ^{1,2}	31 ³	5 oz. tube	19808-3	36
1099L												
<ul style="list-style-type: none"> • Lower viscosity • Sprayable version of 1099 Adhesive 												
	24%	0°F (-18°C)	Thin Liquid	Tan	Spray, Brush	Up to 20 min.	1306 ^{1,2}	643 ^{1,2}	31 ³	5 gal. pail	22578-9	1
4693H												
<ul style="list-style-type: none"> • Clear, elastomeric adhesive • Exceptional adhesion to metal and plastic • Unique in its ability to bond hard-to-hold materials like polypropylene, polyethylene and high impact polystyrene 												
	36%	1°F (-17°C)	Medium Liquid	Clear	Flow, Brush	Up to 60 min.	—	—	22 ³	5 oz. tube	30088-2	36
3M™ Scotch-Grip™ Rubber and Gasket Adhesives												
847												
<ul style="list-style-type: none"> • Quick drying and flexible with fuel and oil resistance • Heat and solvent reactivatable • Curable with heat 												
	36%	0°F (-18°C)	Medium Liquid	Brown	Flow, Brush	Up to 15 min.	200 ⁴	9 ⁴	40 ³	5 oz. tube	19718-5	36
										1 Quart	19721-5	12
1300												
<ul style="list-style-type: none"> • High immediate strength • Fast-drying and heat resistant for rubber and metal 												
	37%	-14°F (-26°C)	Medium Liquid	Yellow	Flow, Brush	Up to 12 min.	549 ¹	136 ⁴	52 ³	5 oz. tube	19868-7	36
4799												
<ul style="list-style-type: none"> • Brushable paste consistency with low soak-in on porous surfaces • Can bond EPDM rubber 												
	36%	-14°F (-26°C)	Thin Paste	Black	Brush, Trowel	Up to 15 min.	—	—	28 ³	5 oz. tube	21354-0	36

Note: The technical information and data on these pages should be considered representative or typical only and should not be used for specification purposes.

1 Aluminum to aluminum @ 0.1 inches/minute.

2 Bonds heat cured for 15 minutes @ 324°F, 150 PSI.

3 Canvas to cold rolled steel @ 2.0 inches/minute separation rate.

4 Birch plywood to birch plywood @ 0.1 inches/minute separation rate.

*3M™ Scotch-Grip™ Adhesives will be rebranded 3M™ Scotch-Weld™ Adhesives in 2007.

3M™ Non-Structural Adhesives (cont.)



3M™ Scotch-Weld™ Neoprene Adhesives

This line offers a wide range of choices for contact adhesives applications. Select from bonding ranges, strengths, solids contents and solvent formulations to meet requirements for bonding laminate, foam and more.

Product Number/ Description	Solids Weight (Approx.)	Flash Point (Closed Cup)	Consis- tency	Color Dry Film	Applic- ation Method	Bonding Range	Overlap Shear Strength (PSI)		Peel Strength (PSI)	Color	Size	UPC (021200-)	Qty./ Case
							75°F (24°C)	180°F (82°C)	75°F (24°C)				
5													
<ul style="list-style-type: none"> • Rapid strength buildup • Heat and creep resistant bond • Bonds many high pressure plastic laminated to metal and other surfaces 	19%	-14°F (-26°C)	Thin Liquid	Green, Light Yellow	Spray	30 min. max.	482 ¹	65 ¹	19 ²	Green	5 Gal. Pail	21232-1	1
										Light Yellow		20333-6	
10													
<ul style="list-style-type: none"> • Similar performance to 5 • Brushable with higher coverage • Bonds aluminum, steel, rubber and other porous and non-porous materials to each other or to themselves 	22%	-14°F (-26°C)	Thin Liquid	Light Yellow	Brush, Roller	30 min. max.	482 ¹	65 ¹	19 ²	Light Yellow	1 Quart	20272-8	12
											1 Gal.	20274-2	4
											5 Gal. Pail	20276-6	1
1357													
<ul style="list-style-type: none"> • Rapid buildup to a very high strength bond for metal • Resists heat and continuous load stress • Adheres well to metal, rubber, wood and glass 	25%	-14°F (-26°C)	Thin Liquid	Gray- green, Light Yellow	Brush, Spray	30 min. max.	536 ¹	199 ¹	42 ²	Gray Green	5 oz. tube	19887-8	36
											1 Pint	19890-8	12
												1 Quart	
										1 Gal.	19894-6	4	
											Light Yellow		22586-4
										5 Gal. Pail	19897-7	1	
Light Yellow	64963-9												

1 Birch plywood to birch plywood @ 0.1 inches/minute separation rate.

2 Canvas to cold rolled steel @ 2.0 inches/minute separation rate.

3M™ Non-Structural Adhesives (cont.)



3M™ Sealants

3M™ Scotch-Seal™ Sealants: Helps keep air, dirt, fuel, cold, heat or other elements in or out, you'll find formulations from acrylic to polyurethane.

Product Number/Description	Solids Weight (Approx.)	Flash Point (Closed Cup)	Consistency	Color (Dry)	Application Method	Cure or Dry Time	Service Temperature Range	Size	UPC (02100-)	Qty./Case
3M™ Scotch-Seal™ Polyurethane Sealant 540										
<ul style="list-style-type: none"> • Polyurethane • One-component • Moisture cures rapidly to flexible seal/bond for many plastics, metal, wood and more • 250 psi tensile strength 	90%	136°F (58°C)	Mastic	Gray	Hand or Pressure Caulk	24 hours (3/16" dia. bead)	-40° to 194°F (-40° to 90°C)	10.5 oz. cartridge	41594-4	12
								400ml sausage pack	96277-6	
3M™ Scotch-Seal™ Polyurethane Adhesive Sealant 560										
<ul style="list-style-type: none"> • Similar to 540 but with 580 psi tensile strength • May replace mechanical fasteners 	90%	136°F (58°C)	Mastic	Gray	Hand or Pressure Caulk	24 hours (3/16" dia. bead)	-40° to 194°F (-40° to 90°C)	1/10 gallon cartridge	41596-8	12
3M™ Scotch-Seal™ Tamper Proof Sealant 1252										
<ul style="list-style-type: none"> • Fire retardant seal • Resists oil, gasoline, water, jet fuel and fungus • Will not corrode metal • Tack-free in 20 seconds 	70%	20°F (-7°C)	Thin Paste	White	Pressure-Flow Gun	24 hours (1/8" dia. bead)	-20° to 250°F (-29° to 121°C)	5 oz. tube	20193-6	36
3M™ Scotch-Seal™ Metal Sealant 2084										
<ul style="list-style-type: none"> • Seals metal to glass in windows and doors • Resists weather, water, oil and gasoline 	46%	0°F (-18°C)	Heavy Liquid	Aluminum	Brush or Flow	24 hours (1/8" dia. bead)	-30° to 250°F (-34° to 121°C)	5 oz. tube	20227-8	36

Note: The technical information and data on these pages should be considered representative or typical only and should not be used for specification purposes.

*3M™ Scotch-Seal™ Sealants will be rebranded 3M™ Scotch-Weld™ Sealants in 2007.

3M™ Structural Adhesives



3M™ Scotch-Weld™ Epoxy and Acrylic Adhesives

Used as an alternative for mechanical or fusion fastening due to its greater design latitude, cleaner lines, lighter weight, greater durability, less machining and often less cost.

Product Number/Color/Description	Mix Ratio (Vol) B:A	Approx. ² Viscosity 75°F (24°C) (CPS)	Approx. ³ Worklife at 75°F (24°C)	Ave. T-Peel ⁴ at 75°F (24°C) (PIW)	Overlap Shear Strength ⁵ (PSI)			Size	UPC (021200-)	Qty./Case
					-67°F (-55°C)	75°F (24°C)	180°F (82°C)			
Epoxy										
3M™ Scotch-Weld™ Epoxy DP100 Clear										
<ul style="list-style-type: none"> • Fast cure rigid epoxy • 15–20 minute handling strength • Transparent when cured 	1:1	13,000	4 min.	2	900	1500	300	1.7 fl. oz	22648-9	12

3M™ Structural Adhesives (cont.)

Product Number/Color/ Description	Mix Ratio (Vol) B:A	Approx. ² Viscosity 75°F (24°C) (CPS)	Approx. ³ Worklife at 75°F (24°C)	Ave. T-Peel ⁴ at 75°F (24°C) (PIW)	Overlap Shear Strength ⁵ (PSI)			Size	UPC (021200-)	Qty./ Case
					-67°F (-55°C)	75°F (24°C)	180°F (82°C)			
Epoxy										
3M™ Scotch-Weld™ Epoxy Adhesive DP100 Plus Clear										
<ul style="list-style-type: none"> Higher peel and shear strength version of 178-100 	1:1	8,500	4 min.	10	3000	3500	200	1.7 fl. oz.	87195-5	12
3M™ Scotch-Weld™ Epoxy Adhesive DP420 Off-White										
<ul style="list-style-type: none"> Medium worklife, toughened epoxy 1–2 hours handling strength Tough, durable structural bonds Very high performance, two-part epoxy adhesive Great for bonding metal, plastic and wood 	2:1	30,000	15 min.	50	4500	4500	1260	1.2 fl. oz.	82236-0	12
3M™ Scotch-Weld™ Epoxy Adhesive 2216 B/A Gray										
<ul style="list-style-type: none"> Long worklife flexible epoxy 8–12 hrs. handling strength Bonds plastic, metal and other dissimilar materials 	2:3	80,000	90 min.	25	2000	2500	400	Quart Kit	20356-5	6
3M™ Scotch-Weld™ Epoxy Adhesive DP460 Off-White										
<ul style="list-style-type: none"> Long worklife toughened epoxy 2–4 hours handling strength Very high performance epoxy adhesive Great for bonding a wide variety of materials with outstanding reliability and durability 	2:1	30,000	60 min.	60	4500	4500	700	1.25 fl. oz.	82225-4	12
Acrylic										
3M™ Scotch-Weld™ Structural Plastic Adhesive DP810 Black, Tan										
<ul style="list-style-type: none"> Acrylic bonds many metals and plastics without surface prep Fast strength buildup Fully cured in 8 hours Low odor High peel and shear strength on slightly oily steel, aluminum, glass and painted surfaces 	1:1	18,000 – 30,000	8–10 min.	30	1200	3600	500	1.7 fl. oz.	49077-4 (Black)	12
									31310-3 (Tan)	
3M™ Scotch-Weld™ Structural Plastic Adhesive DP810NS Clear										
<ul style="list-style-type: none"> Non-sag version of DP810 10-15 minute handling strength 	1:1	90,000 – 95,000	8–10 min.	20	1200	4000	500	1.7 fl. oz.	49082-8	12
3M™ Scotch-Weld™ Structural Plastic Adhesive DP8005 Translucent, Black										
<ul style="list-style-type: none"> 2-part acrylic adhesive bonds to polyethylene and polypropylene with no surface preparation Tough bond strength to resist vibration and impact Bonds most difficult-to-bond LSE (low surface energy) plastics 	10:1	27,500	2.5–3 min.	16	—	2000	300	35mL	41547-0 (Translucent)	12
									45167-6 (Black)	

Note: The technical information and data on these pages should be considered representative or typical only and should not be used for specification purposes.

1 Color is mixed if two-part product

2 Brookfield viscometer viscosity values are typical values for the mixed product

3 The time during which an adhesive will adequately wet-out on a substrate

4 180° peel tested on .030" aluminum per ASTM D 1876-61T



5 Tested per ASTM D 1002-64

3M™ Structural Adhesives (cont.)



3M™ Scotch-Weld™ EPX™ Applicators & Accessories

Mixing nozzle will perform to your requirements. With consistent air pressure for easy uniform application, the Duo-Pak cartridge will give you the flow rate needed. Fast, convenient way to simultaneously meter, mix and apply two-part adhesives and potting compounds. System features handy Duo-Pak Adhesive Cartridges that snap quickly into the durable, lightweight EPX applicator. A slight squeeze on the trigger advances the plunger into the cartridge. Accurate measurement and the mixing nozzle provides thorough mixing and precise placement of material. Ideal system for assembly, maintenance and in-field service.

Product Number/Description		Size	UPC (021200-)	Qty./Case
	3M™ Scotch-Weld™ EPX Metal Applicator #9470 with 2:1 Plunger	50mL	21789-0	10
	3M™ Scotch-Weld™ EPX 50mL Pneumatic Applicator with 2:1 Plunger	50mL	83528-5	1
	3M™ Scotch-Weld™ EPX Plus II Applicator with 2:1 and 1:1 Plunger (manual)	50mL	50004-6	10
	3M™ Scotch-Weld™ EPX Plus II Square Gold Mixing Nozzle	127mm	97331-4	36
	3M™ Scotch-Weld™ EPX Mixing Nozzle #9742 for 50ml applicator	50mL	21791-3	72
	3M™ Scotch-Weld™ EPX 2:1 Plunger Assembly for 50ml applicator	—	82314-5	10
	3M™ Scotch-Weld™ EPX 10:1 Plunger (manual)	50mL	50007-7	10



3M™ Scotch-Weld™ Instant Adhesive

For speed and performance, you'll find a product with the right combination of bond strength, cure time and viscosity.

Product Number/Description	Base	Time ¹ to Handling Strength (sec.)	Viscosity (CPS)	Ave. T-Peel ² at 75°F (24°C) (PIW)	Overlap Shear Strength ³ at 75°F (24°C) (PSI)						Size	UPC (021200-)	Qty./Case
					Steel	Aluminum	Nitrile Rubber	Neoprene Rubber	APS	Rigid PVC			
CA40H													
<ul style="list-style-type: none"> • Better void filling capabilities • Good adhesion to aluminum, EPDM, rubber and flexible vinyl • Good resistance to soap solutions and isopropyl alcohol 													
	Ethyl	5-40	400-600	1-2	1500	1500	35*	55*	900*	1000*	1 oz.	21073-0	12

Note: The technical information and data on these pages should be considered representative or typical only and should not be used for specification purposes.

1 The time it takes assembled parts to reach a strength where further handling and processing can take place. Times will depend on surface to be bonded, temperature and humidity.

2 Tested per ASTM D1876-61T

3 Tested per ASTM D1002-64

* Substrate Failure

3M™ Structural Adhesives (cont.)

3M™ Scotch-Weld™ Anaerobic Adhesives

To seal gaps and tighten the fit between metal surfaces. Apply on target and cure quickly in the absence of air.

3M™ Scotch-Weld™ Threadlockers: Weld fasteners in place for blind holes and through holes and prevent loosening from vibration.



Product Number/Description		Removal (torque-break/prevail)	Bolt Size	Color	Size	UPC (048011-)	Qty./Case
3M™ Scotch-Weld™ Threadlocker							
3493							
	<ul style="list-style-type: none"> • Screw grade • Thixotropic to reduce flow after application to surface • Hand tools for disassembly 	Low 50/30 lb. in	Less than 5/16"	Purple	0.5mL	57299-4	50
					10mL	56798-3	5
					50mL	57300-7	5
					250mL	57301-4	4
3494							
	<ul style="list-style-type: none"> • Nut grade • Thixotropic to reduce flow after application to surface • Oil tolerant • Hand tools for disassembly 	Medium 120/50 lb. in.	Up to 3/4"	Purple	0.5mL	57302-1	50
				Blue	10mL	57304-5	5
					50mL	57305-2	5
					250mL	57306-9	4
3495							
	<ul style="list-style-type: none"> • Permanent, controlled torque • High breakaway, reduced prevailing torque • Heat and hand tools for disassembly 	Medium/high 200/100 lb. in.	Up to 1"	Red	0.5mL	57307-6	50
					10mL	57309-0	5
					50mL	57310-6	5
					250mL	57311-3	4
3496							
	<ul style="list-style-type: none"> • Permanent • Low viscosity • High breakaway, high prevailing torque • Heat and hand tools for disassembly 	High 230/330 lb. in	Up to 1"	Red	10mL	57312-0	5
					50mL	57314-4	5
					250mL	57315-1	4
3497							
	<ul style="list-style-type: none"> • Permanent • High viscosity • Wide temperature range -65° to 450°F (-55° to 232°C) • High breakaway, high prevailing torque • Heat and hand tools for disassembly 	High 130/225 lb. in.	Up to 1-1/2"	Red	10mL	57316-8	5
					50mL	57318-2	5
					250mL	57319-9	4
3498							
	<ul style="list-style-type: none"> • Wicks into pre-assembled bolts • Seals welds and porous metals • Locks and seals small compression and ferrule fittings • Service temperature to 400°F (204°C) • Heat and hand tools for disassembly 	Medium 85/250 lb. in.	Greater than 1/4"	Green	10mL	57320-5	5
					50mL	57322-9	5
					250mL	57323-6	4

Note: The technical information and data on these pages should be considered representative or typical only and should not be used for specification purposes.

Adhesives

3M™ Structural Adhesives (cont.)

3M™ Scotch-Weld™ Thread Sealants: seal instantly to stop leaks when applied to the threads or compression fittings of most metal or certain plastic pipes.

Product Number/Description		Removal Torque	Pipe Size	Color	Size	UPC (048011-)	Qty./Case
3M™ Scotch-Weld™ Thread Sealant							
3477							
 379722	<ul style="list-style-type: none"> • Medium viscosity with no fillers • High pressure sealant for all hydraulic and pneumatic fittings • No clogging of valves or filters • Hand tool disassembly for pipes under 1"; heat required for over 1" 	Low 15 lb. in.	Up to 2"	Purple	50mL	57324-3	5
					250mL	57326-7	4
3478							
 375389	<ul style="list-style-type: none"> • Faster cure than 3477 • Wide temperature range from -65° to 400°F (-55° to 204°C) • General purpose for stainless steel, Monel®, and other inactive surfaces • Hand tool disassembly 	Low 25 lb. in.	Up to 2"	White	6mL	57327-4	50
					50mL	57329-8	5
					250mL	57330-4	4
3479							
 379726	<ul style="list-style-type: none"> • High lubricity for easy threading • Instant seal with slow cure • Re-adjustable for up to 24 hours • Wide temperature range from -65° to 400°F (-55° to 204°C) • Hand tool disassembly 	Medium 50 lb. in.	Up to 3"	White	6mL	57331-1	50
					50mL	57333-5	5
					250mL	57334-2	4

Note: The technical information and data on these pages should be considered representative or typical only and should not be used for specification purposes.

3M™ Scotch-Weld™ Gasket Makers: fill voids between metal flanges.

Product Number/Description	Hardness	Gap Fill Primed/ Unprimed	Color	Size	UPC (048011-)	Qty./Case
3M™ Scotch-Weld™ Gasket Makers						
3453						
<ul style="list-style-type: none"> • General purpose gasketing with wide temperature range from -65° to 400°F (-55° to 204°C) • Hand dispense or screen print • Instant low pressure seal 	Rigid	Up to 0.020"/ 0.010"	Red	50mL	57354-0	5
3454						
<ul style="list-style-type: none"> • Gasketing for aluminum flanges • Does not shrink or relax • Instant low pressure seal without priming 	Flexible	Up to 0.050"/ 0.010"	Red	50mL	57356-4	5
3455						
<ul style="list-style-type: none"> • General purpose gasketing for gearbox covers, pump flanges, fuel and water pumps • Provides instant low pressure seal 	Flexible	Up to 0.050"/ 0.010"	Purple	50mL	57392-2	5

Note: The technical information and data on these pages should be considered representative or typical only and should not be used for specification purposes.

3M™ Structural Adhesives (cont.)

3M™ Scotch-Weld™ Retaining Compounds: bond and seal non-threaded cylindrical assemblies.

Description	Shear Strength	Gap Fill	Color	Size	UPC (048011-)	Qty./Case
3M™ Scotch-Weld™ Retaining Compounds						
3434						
<ul style="list-style-type: none"> • Medium-high strength • High viscosity • Thixotropic to reduce flow after application to surface • Temperature resistance to 450°F (232°C) for cylinder, heat exchanger and other high temperature applications 	2500	Up to 0.015"	Green	50mL	57335-9	5
3435						
<ul style="list-style-type: none"> • Medium strength • Low viscosity general purpose compound for rigid cylindrical assemblies • Augments press fits 	2500	Up to 0.005"	Green	50mL	57342-7	5
3436						
<ul style="list-style-type: none"> • Medium strength • Gel formulation for repair of worn shafts, splines, keyways, and housings 	3250	Up to 0.020"	Gray	50mL	57346-5	5
3437						
<ul style="list-style-type: none"> • High strength • Medium viscosity • For rigid and slip fit assemblies 	3700	Up to 0.015"	Green	50mL	57350-2	5

Note: The technical information and data on these pages should be considered representative or typical only and should not be used for specification purposes.



3M™ Scotch-Weld™ Threadlockers fill and seal threads completely to help stop corrosion, rust and leaks. Securely hold even dissimilar metals.



To save the cost of leaking fluid or gas, 3M™ Scotch-Weld™ Thread Sealants cure quickly to a tight, continuous seal without the creep and shrinkage of pastes.



3M™ Scotch-Weld™ Gasket Makers eliminate pre-cut or compression gaskets, or hold pre-cut gaskets in place during production. Seal without shimming effect or creeping.

3M™ Protective Tapes

Tape Number Identification Guide

Film Thickness
(nominal thickness in mils)
Exception: 25A10 - 25 = 2.5 mils

Film Color
B – Blue
C – Clear
W – White
X – Black/White
No Letter – Clear

3W26X

Film Type

- 1 – LDPE
- 4 – Polypropylene
- 6 – Polyester
- A – Co-Extruded PE
- E – Co-Extruded PE (Carpet Tape Only)
- U – Translucent UV Stable Film
- W – Co-Extruded PE - Black/White

Adhesive Type

Adhesives:
04, 05, 10
12, 14, 23, 42, 73
25, 26, 29, 43, 56, 58
67, 79, 82, 87, 88, 89
93EZ, 95EZ

Tack Level:
Very Low = VL
Low = L
Moderate = M
High = H
Very High = VH

How to use this selection guide: The 3M™ Protective Tape Products Selection Guide is a quick reference of standard 3M™ Protective Tape Products to help the user select appropriate tapes for consideration and evaluation in their applications. Products are color-coded by product family for easy reference. It is essential that the user evaluate the 3M™ Protective Tape Product to determine whether it is suitable for a particular purpose to meet the user's expectation.

Many factors can affect the use and performance of a 3M™ Protective Tape Product in a particular application:

- Surface texture of substrate
- Surface preparation of substrate (including use of solvents)
- Method and conditions of tape application
- Time and environmental conditions
- Storage conditions

Ordering Information

3M™ Protective Tapes are custom ordered products. Please contact your local 3M Authorized Distributor or your 3M Sales Specialist for ordering information. For further assistance, call PolyMask Corporation at 1-800-241-2031.

Total Tape Thickness		2.0 Mils (0.05mm)											2.5 Mils						
 <p>Product Number (Color Coded by Tape Family)</p>		2A04	2A05	2A10	2A12	2A25	2A26	2A29	2A87	2AU23B/UV	2AU26B/UV	2AU23C/UV	2H83C/25H83C	25A10	25A12	25A25	25A26		
		Backing	Co-Ex.	Co-Ex.	Co-Ex.	Co-Ex.	Co-Ex.	Co-Ex.	Co-Ex.	Co-Ex.	Co-Ex.	Co-Ex.	Co-Ex.	PE	Co-Ex.	Co-Ex.	Co-Ex.	Co-Ex.	
		Tack Level	VL	VL	VL	L	M	M	M	H	L	M	L	H	VL	L	M	M	
Metals Uncoated	Aluminum	Mill Finished																	
		Galvanized																	
		Anodized Specular																	
		Anodized – Flat																	
	Stainless Steel	#2B Annealed																	
		#4 Mill Polished																	
		#8 Mirrored																	
		#10 Mirrored																	
Steel	Laser Cuttable																		
Coated — Steel or Aluminum	Embossed	Flat																	
		Gloss																	
	Matte																		
	Bronze																		
	Dissimilar Metals																		
	Automotive Clear Coat																		

3M™ VHB™ Tapes

For 25 years, engineers have been specifying 3M™ VHB™ Tapes to permanently bond and seal many metals, plastics, and other surfaces for increased productivity, high strength, long term durability and improved appearance.



3M™ VHB™ Tape's all-acrylic construction seals against moisture and most solvents, providing long-term resistance to UV and temperature cycles. The tape's unique foam acts as a shock absorber for outstanding impact resistance. Unlike the stress points common to mechanical fasteners, 3M™ VHB™ Tapes distribute the stress. You can use thinner, light-weight materials with less material fatigue.



360838

Product Number		Color	Temperature Resistance		
			Short	Long	
4941	(45 mils)	Gray	300°F	200°F	Conformable and plasticizer resistant. Good adhesion to metals, plastics and plasticized vinyls.
4611	(45 mils)	Dark Gray	450°F	300°F	Bonds to bare metal and holds parts together during the washes and high temperature bake of a powder paint cycle. Used for hat channel and stiffeners.
5952	(45 mils)	Dark Gray	300°F	200°F	Bonds to most liquid and powder painted surfaces, and ABS blends, without the need to prime the surface first.
4945	(45 mils)	White	300°F	200°F	Plasticizer resistant. High strength firm core. Bonds to most painted substrates. Good adhesion to substrates containing plasticizers.
4950	(45 mils)	White	300°F	200°F	Bonds to most metals and high surface energy substrates.

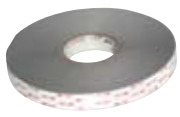
Note: The technical information and data on these pages should be considered representative or typical only and should not be used for specification purposes.

Product Number	Size	UPC (021200-)	Qty./Case
4941			
	1/2" x 36 yds.	64886-1	18
	3/4" x 36 yds.	64887-8	12
	1" x 36 yds.	64888-5	9
4611			
	1/2" x 36 yds.	56375-1	18
	3/4" x 36 yds.	56002-6	12
	1" x 36 yds.	56146-7	9
5952			
	1/2" x 36 yds.	59967-5	18
	1" x 36 yds.	56229-7	9
4945			
	1/2" x 36 yds.	16961-8	18
	3/4" x 36 yds.	16954-0	12
	1" x 36 yds.	16955-7	9
4950			
	1/2" x 36 yds.	18090-3	18
	3/4" x 36 yds.	18091-0	12
	1" x 36 yds.	18092-7	9

To evaluate how 3M™ VHB™ Tapes can be used in your applications, contact your 3M Sales Specialist or call 1-866-279-1288, ext. 8005.



360843

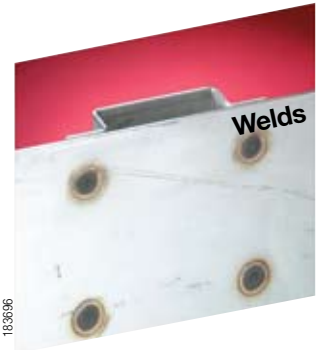

Welds

183696



Rivets

360844



360845







199234



3M™ VHB™ Tapes



183697

3M™ Masking Products

 CLASS I MASKING	 Increasing Holding Power, Line Sharpness, and Clean Removal	Tapes with best-in-class holding power for critical paint lines and clean removal on high valued products or processes.	2693 Up to 325°F (163°C)
			231 Up to 300°F (149°C)
			232 Up to 250°F (121°C)
 CLASS II MASKING		Tapes with reliable masking and clean removal on surfaces for functional coatings or paints, splicing, and heavy duty maintenance.	2380 Up to 325°F (163°C)
			2364 Up to 300°F (149°C)
			234 Up to 250°F (121°C)
 CLASS III MASKING		Tapes with clean removal for light duty bundling, attaching and labeling.	2307 Up to 200°F (93°C)
			200 Up to 200°F (93°C)
			2214 Up to 150°F (66°C)

Increasing Temperature Performance (30 minute bake) 

- What is your application?
- To what temperature will the tape be exposed during use?
- Do you need maximum holding power during use?
- Do you need maximum paint edge sharpness when the tape is removed?
- Do you want to remove the tape without slivering and adhesive residue?

Product Number/Description	Backing/Adhesive	Total Thickness mils (mm)	Temperature Range °F (°C)	Size	UPC (021200-)	Qty./Case	
3M™ Masking Products — Class I Masking							
Scotch® Premium High Performance Masking Tape 2693							
 50862	<ul style="list-style-type: none"> • Designed for applications where very aggressive room temperature and high temperature holding is required • Excellent for multi-bake paint cycles 	Tan Mini-Crepe Paper/Rubber	8.5 (0.21)	Up to 325°F (163°C)*	24mm x 55mm	37629-0	36
					36mm x 55mm	41121-2	24
					48mm x 55mm	37630-6	
					72mm x 55mm	42979-8	12
Scotch® Paint Masking Tape 231							
 86989	<ul style="list-style-type: none"> • Excellent for paint masking • Sticks at a touch and stays put • Tough and smooth high performance crepe paper tape • All-purpose masking tape 	Natural Colored Crepe Paper/Rubber	7.6 (0.19)	Up to 300°F (149°C)*	24mm x 55mm	03777-1	36
					36mm x 55mm	04111-2	24
					48mm x 55mm	04237-9	
					72mm x 55mm	04936-1	12
Scotch® High Performance Masking Tape 232							
 13373	<ul style="list-style-type: none"> • Excellent for paint masking • Sticks at a touch and stays put • Tough and smooth high performance crepe paper tape 	Natural Colored Crepe Paper/Rubber	6.3 (0.16)	Up to 250°F (121°C)*	24mm x 55mm	02854-0	36
					36mm x 55mm	02855-7	24
					48mm x 55mm	04240-9	
					72mm x 55mm	02858-8	12

Note: The technical information and data on these pages should be considered representative or typical only and should not be used for specification purposes.

* Up to 30 minutes

** Up to 1 hour

Tapes

3M™ Masking Products (cont.)

Product Number/Description	Backing/Adhesive	Total Thickness mils (mm)	Temperature Range °F (°C)	Size	UPC (021200-)	Qty./Case	
3M™ Masking Products — Class II Masking							
Scotch® Performance Masking Tape 2380							
 50860	<ul style="list-style-type: none"> Designed for industrial paint masking applications Helps assure a good paint line whether air drying or oven baking 	Mini-Crepe Paper/ Natural Synthetic/ Rubber Blend	7.5 (0.19)	Up to 325°F (163°C)*	24mm x 55m	44583-5	36
					36mm x 55m	44582-8	24
					48mm x 55m	44581-1	
					72mm x 55m	44580-4	12
Scotch® Performance Masking Tape 2364							
 50859	<ul style="list-style-type: none"> For general masking applications where good holding power and temperature performance is required Designed for many industrial applications Easy tearing and sliver resistance, controlled unwind, clear removal 	Tan Crepe Paper/ Natural Synthetic/ Rubber Blend	6.5 (0.16)	Up to 300°F (149°C)*	24mm x 55m	43352-8	36
					36mm x 55m	43353-5	24
					48mm x 55m	43354-2	
					72mm x 55m	43355-9	12
Scotch® General Purpose Masking Tape 234							
 169188	<ul style="list-style-type: none"> Excellent control unwind for paint masking Resists transfer and slivering Conforms well 	Natural Colored Crepe Paper/ Rubber	6.0 (0.15)	Up to 250°F (121°C)*	24mm x 55m	02982-0	36
					36mm x 55m	02983-7	24
					48mm x 55m	04244-7	
					72mm x 55m	02985-1	12
3M™ Masking Products — Class III Masking							
3M™ Masking Tape 2307							
 86975	<ul style="list-style-type: none"> General purpose grade Solvent-free construction; non-critical paint masking 	Natural Colored Crepe Paper/ Rubber	5.6 (0.14)	Up to 200°F (93°C)**	12mm x 55m	71116-9	72
					18mm x 55m	71117-6	48
					24mm x 55m	71118-3	36
					36mm x 55m	71119-0	24
					48mm x 55m	71120-6	
					60mm x 55m	55672-2	16
					72mm x 55m	71121-3	12
Product Number/Description							
3M™ Paper Tape 200							
 13372	<ul style="list-style-type: none"> Natural colored, 4.5 mils (0.11mm) crepe paper tape with rubber adhesive Used for holding, bundling, sealing, non-critical masking, and a vast number of other jobs where a pressure sensitive tape is needed 	Natural Colored Crepe Paper/ Rubber	4.5 (0.11)	Up to 200°F (93°C)*	12mm x 55m	53469-5	72
					18mm x 55m	53464-0	48
					24mm x 55m	53465-7	36
					36mm x 55m	53470-1	24
					48mm x 55m	53466-4	
					72mm x 55m	53467-1	12

Note: The technical information and data on these pages should be considered representative or typical only and should not be used for specification purposes.

* Up to 30 minutes

** Up to 1 hour

3M™ Masking Products (cont.)

Product Number/Description	Backing/Adhesive	Total Thickness mils (mm)	Temperature Range °F (°C)	Size	UPC (021200-)	Qty./Case	
3M™ Masking Products — Class III Masking							
3M™ Paper Masking Tape 2214							
 <p>148594</p>	<ul style="list-style-type: none"> Economical, quality, general purpose paper tape with rubber adhesive Use for bundling, sealing, holding and non-critical indoor jobs 5.3 mils pressure sensitive tape resists slivering 	Natural Colored Crepe Paper/Rubber	5.3 (0.13)	Up to 150°F (66°C)*	12mm x 55m	45587-2	72
					18mm x 55m	26074-2	48
					24mm x 55m	26075-9	36
					36mm x 55m	26076-6	24
					48mm x 55m	26077-3	
					72mm x 55m	26078-0	12

Note: The technical information and data on these pages should be considered representative or typical only and should not be used for specification purposes.

* Up to 30 minutes

Product Number/Description	Size	UPC (051131-)	Qty./Case	
3M™ Masking Products — Painting				
3M™ Scotchblok™ Masking Paper Gold				
 <p>12026</p>	<ul style="list-style-type: none"> Protects against dust contamination from its own paper fibers Holds up well under wet sanding conditions Excellent conformability No solvent penetration Bake cycles up to 225°F (107°C) for 30 minutes Gold 	18" x 750'	06718-9	2
3M™ Masking Paper White				
 <p>12029</p>	<ul style="list-style-type: none"> For utility applications Acceptable conformability 24 lbs. treated paper Bake cycles up to 400°F (204°C) for 30 minutes White 	18" x 750'	06539-0	2
3M™ Masking Products — Welding				
3M™ Welding and Spark Deflection Paper				
 <p>43640</p>	<ul style="list-style-type: none"> Flame retardant Repositionable adhesive on one side Formulated to protect vertical surfaces, glass and paint from welding spatter and grinding sparks Easy to use roll form 	24" x 150'	05916-0	2

Note: The technical information and data on these pages should be considered representative or typical only and should not be used for specification purposes.

3M™ High Strength Tapes— Bundling and Reinforcing Solutions

3M has developed a wide range of high strength tapes, resistant to abrasion, moisture and scuffing, for the bundling and reinforcing challenges faced in the industrial marketplace. Applications for these high performance products can vary dramatically — from tabbing the end lap of metal coils to stabilizing pallets to reinforcing large bulk containers or just a single carton.

These tapes balance tensile strength and adhesive holding power, even under extreme conditions, providing secure, cost-effective solutions for a variety of strapping, bundling and reinforcing applications.





Coil Tabbing

- 880NR
- 898NR
- 8919





Pipe Bundling

- 880
- 894

Product Number/ Description	Backing Color	Backing	Reinforcement	Adhesive	Elongation at Break	Tensile Strength (lbs./in.)	Size	UPC (021200-)	Qty/ Case
Coil Tabbing									
Scotch® High Performance Filament Tape 880NR									
<ul style="list-style-type: none"> • Excellent balance of high initial adhesion and long-term holding power to fiberboard, metals, printed and painted surfaces including applications exposed to higher temperatures and/or lightly oiled surfaces • Applications include bundling of heavy or sharp objects such as tubing and rods and tabbing the end lap of large metal coils 									
 195276	Clear	Scotchpar™ Film	Polyester	Natural rubber resin	19%	270	18mm x 55m	48445-2	48
							24mm x 55m	48446-9	36
							48mm x 55m	48448-3	24
Scotch® High Performance Filament Tape 898NR									
<ul style="list-style-type: none"> • Formulated to provide balanced performance having both high adhesion and long term holding power 									
 195278	Clear	Scotchpar™ Film	Glass yarn	Natural rubber resin	3%	380	18mm x 55m	48450-6	48
							24mm x 55m	48451-3	36
							48mm x 55m	48453-7	24
Scotch® Filament Tape 8919									
<ul style="list-style-type: none"> • Ideal for securing hinged appliance doors or parts during shipping and the end lap of steel or aluminum coils • Specially formulated adhesive to provide clean removal and stain resistance on certain substrates 									
 195267	Clear	Scotchpar™ Film	Glass yarn	Natural rubber resin	3%	380	18mm x 55m	39875-9	48
							24mm x 55m	39876-6	36
							48mm x 55m	39878-0	24





Note: The technical information and data on these pages should be considered representative or typical only and should not be used for specification purposes.

3M™ High Strength Tapes— Bundling and Reinforcing Solutions (cont.)

Product Number/ Description	Backing Color	Backing	Reinforcement	Adhesive	Elongation at Break	Tensile Strength (lbs./in.)	Size	UPC (021200-)	Qty./ Case
Pipe Bundling									
Scotch® Filament Tape 880									
<ul style="list-style-type: none"> • High impact and cut resistance • Long term holding power to fiberboard, non-oily metals and printed and painted surfaces 									
 <small>195275</small>	Clear	Scotchpro™ Film	Polyester	Synthetic rubber resin	19%	270	12mm x 55m	39842-1	72
							18mm x 55m	39844-5	48
Scotch® Filament Tape 894									
<ul style="list-style-type: none"> • General purpose packaging tape • When used in bundling, reinforcing or coil tabbing applications with high temperatures and/or oily surfaces, tests should be conducted to determine the tape's suitability 									
 <small>195271</small>	Black	Scotchpro™ Film	Glass yarn	Synthetic rubber resin	4.5%	300	18mm x 55m	88131-2	48

Note: The technical information and data on these pages should be considered representative or typical only and should not be used for specification purposes.









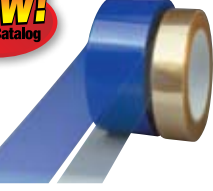

Scotch® Filament Tape Dispensers

Product Number/Description	Size	UPC (021200-)	Qty./Case
Scotch® Filament Tape Dispenser H-120			
 <small>63625</small> <ul style="list-style-type: none"> • Portable dispenser with durable metal construction for carton sealing • Accommodates filament tape up to 1" (24mm) for high volume applications with fewer stops • Quickly and easily refillable. 	1"	11041-2	48
Scotch® Box Sealing Tape Dispenser H-123			
 <small>63604</small> <ul style="list-style-type: none"> • Lightweight, compact, hand-held dispenser • For pressure sensitive tapes up to 72mm wide x 55m (3" wide x 60 yds.) on 3" cores • Sturdy metal construction for durable, long-life performance. 	3"	11102-0	6
Scotch® Box Sealing Tape Dispenser H-128			
 <small>188797</small> <ul style="list-style-type: none"> • Durable, heavy-duty metal dispenser • Provides a quick and easy method of applying H-seal and center-seam closures of RSCs • Lightweight steel construction • Adaptable for a variety of on-the-spot applications • Accommodates tapes up to 2" (48mm) wide on a 3" core. 	2"	06909-3	6
Scotch® Definite Length Dispenser M-82			
 <small>100370</small> <ul style="list-style-type: none"> • Heavy-duty dispenser • Handles multiple tape rolls simultaneously from 1/2" (12mm) to a maximum combined width of 4" (98mm) • Applications include definite tape lengths for box closure, holding, appliance and electronics reinforcing, strapping, or bundling, and lift-flap taping on Basillod containers 	1-1/2"	18959-3	1

Tapes

3M™ Specialty Tapes

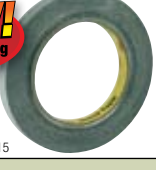
Whether you need an acid-resistant tape for plating masking or a tape that will come off cleanly after high temperature powder coating or a tape with thermal conductivity, you can find it in 3M™ Specialty Tape Solutions.

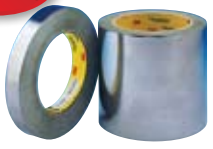
Product Number/Description	Color	Backing	Adhesive	Elongation at Break	Tensile Strength (lbs./in.)	Size	UPC (021200-)	Qty./Case	
3M™ Polyester Tapes 8901/8902									
  50873	<ul style="list-style-type: none"> Use as a maskant with easy removal for powder coat painting Polyester film that retains flexibility and thermal resistance and is abrasion, chemical and thermal resistant to help reduce failures due to cracking and backing deterioration Silicone adhesive for higher heat resistance (up to 400°F; 204°C) than many other adhesives to help reduce failure due to softening, oozing and adhesive transfer 								
	8901	Blue	Polyester	Silicone	115%	28	1" x 72 yds.	85764-5	36
							2" x 72 yds.	85765-2	24
	8902	Blue	Polyester	Silicone	130%	53	1" x 72 yds.	85766-9	36
	2" x 72 yds.						85767-6	24	
3M™ General Purpose Polyester Tape 8951/8952									
  85697	<ul style="list-style-type: none"> Designed to provide clean removal during hi temperature/hi pressure masking operations Polyester film retains flexibility and thermal resistance to help reduce cracking Abrasion, chemical and thermal resistance helps reduce backing deterioration Hi heat resistant (up to 425°F; 218°C) silicone adhesive helps reduce failure due to softening, oozing and adhesive transfer 								
	8951	Blue	Polyester	Silicone	100%	30	1" x 72 yds.	48225-0	36
							2" x 72 yds.	48227-4	24
	8952	Blue	Polyester	Silicone	110%	55	1" x 72 yds.	48230-4	36
	2" x 72 yds.						48232-8	24	
3M™ Glass Cloth Tape 361									
  50863	<ul style="list-style-type: none"> For extreme temperatures 5.4 mil backing thickness Can withstand intermittent temperatures up to 550°F (288°C) or higher, depending upon the type and duration of the heat source 								
	361	White	Glass Cloth	Silicone	10%	182	1" x 60 yds.	03017-8	36
							2" x 60 yds.	04275-1	24
3M™ Electroplating Tape 470									
  51586	<ul style="list-style-type: none"> Excellent resistance to most chemicals used in typical electroplating operations Resists most common solvents—care should be taken to avoid ketones, chlorinated hydrocarbons and esters found in lacquer thinners, degreasers, paint strippers, etc. which may cause the backing to swell or curl Conformable Can be qualified to meet Federal Specification HH-T-0025 (GSA-FSS) 								
	470	Tan	Pigmented Vinyl Plastic	Rubber	180%	20	1" x 36 yds.	85616-7	36
							2" x 36 yds.	85617-4	24
3M™ Aluminum Foil Tape 425									
  196215	<ul style="list-style-type: none"> Good candidate as a maskant in electroplating of aluminum because it will not contaminate the bath Adhesion to steel: 47 oz./in. width An acrylic adhesive, combined with a durable aluminum backing, offers ideal properties for long serviceable life indoors and out Aluminum backing provides excellent reflection of both heat and light 								
	425	Shiny Silver	Dead Soft Aluminum	Acrylic	8%	30	1" x 60 yds.	60572-7	36
							2" x 60 yds.	60574-1	24
3M™ Lead Foil Tape 420									
  145295	<ul style="list-style-type: none"> Can be die-cut into specific shapes Very good conformability Adhesion to steel: 45 oz./in. width Good thermal properties and will perform over a wide variety of temperature conditions (-60° to 225°F; -54° to 106°C); use indoors or out Electrically and thermally conductive 								
	420	Dark Silver	Lead Foil	Rubber (Green)	12%	20	1" x 36 yds.	04923-1	9
							2" x 36 yds.	03081-9	6
							1" x 36 yds.	04917-0	9
							2" x 36 yds.	03195-3	6

Scotch® Box Sealing Tapes



With Scotch Box Sealing Tapes, you have the flexibility to seal boxes in a wide range of environments for durable and secure closure in packing stations. The tape is tough enough to resist score-line breaking and center-seam splitting, even when subject to rough handling.

Features: Strong backing with either pressure-sensitive hot melt synthetic rubber resin adhesive or acrylic adhesives for reliable closures. A variety of hand-held dispensers allow for quick and easy application.



Product Number/Description		Backing/ Adhesive	Total Thickness mils (mm)	Color	Size	UPC (021200-)	Qty./ Case	
Scotch® Superior Performance Box Sealing Tape 375								
<p>63222</p>	<ul style="list-style-type: none"> • Excellent performance box sealing tape • Seals heavy, high-value, over-packed, or under-packed packages • Strong for demanding situations • Meets US postal regulations 	Polypropylene/ Synthetic Rubber	3.1 (.079)	Clear	48mm x 50m	72406-0	36	
					48mm x 914mm	72408-4	6	
					72mm x 50m	72407-7	24	
					72mm x 914mm	72409-1	4	
					Tan	48mm x 50m	72401-5	36
						72mm x 50m	72402-2	24
Scotch® Superior Performance Box Sealing Tape 355								
<p>195356</p>	<ul style="list-style-type: none"> • Used for demanding packaging applications • Considered water resistant as per ASTM D5570 • Adheres instantly to most surfaces, including cartons containing high levels of recycled content • High edge tear and split resistance • Superior performance ensures reliable closures 	Polyester Film/ Hot Melt Rubber-Resin	3.43 (.09)	Clear	48mm x 50mm	72330-8	36	
					48mm x 914mm	72300-1	4	
					72mm x 50mm	72331-5	24	
					72mm x 914mm	72333-9	2	
					Tan	48mm x 50mm	06651-9*	36
						72mm x 50mm	72327-8	24
Scotch® High Performance Box Sealing Tape 373								
<p>226794</p>	<ul style="list-style-type: none"> • High performance packaging tape • Used for box sealing, splicing, recoupage and other demanding packaging applications • Heavy duty, conformable backing • Consistent pressure sensitive hot melt adhesive system • Time proven construction assures high performance in a wide range of environments and applications 	Polypropylene/ Synthetic Rubber	2.5 (.064)	Clear	48mm x 50m	72368-1	36	
					48mm x 914mm	72377-3	6	
					48mm x 1500mm	72379-7	3	
					72mm x 50m	69605-3	24	
					48mm x 100m	73079-5	36	
					72mm x 100m	73080-1	24	
					72mm x 914mm	72378-0	4	
					Tan	48mm x 50m	72359-9	36
						72mm x 50m	72361-2	24
						48mm x 100m	73081-8	36
						72mm x 100m	73082-5	24
						72mm x 100m	73082-5	24
Scotch® Box Sealing Tape 371								
<p>48050</p>	<ul style="list-style-type: none"> • Seals single wall corrugated cartons or bundles a group reliably • Polypropylene backing for tear resistance • Pressure-sensitive rubber adhesive offers quick, moisture proof seal • A good, tight, general purpose seal 	Polypropylene/ Synthetic Rubber	1.9 (.048)	Clear	48mm x 50m	13679-5	36	
					72mm x 50m	19279-1	24	
					48mm x 100m	15873-5	36	
					48mm x 914mm	13681-8	6	
					48mm x 1500mm	61823-9	6	
					72mm x 100m	19280-7	24	
					72mm x 914mm	18198-6	4	
					72mm x 1500mm	62455-1	4	
					Tan	48mm x 50m	14105-8	36
						72mm x 50m	18197-9	24
						48mm x 100m	15872-8	36
						48mm x 914mm	14107-2	6
						72mm x 100m	61525-2	24
						72mm x 100m	61525-2	24

*Order using prefix 051131.

Tapes

Scotch® Box Sealing Tapes (cont.)

NEW!
to Catalog





Product Number/Description	Backing/ Adhesive	Total Thickness mils (mm)	Color	Size	UPC (021200-)	Qty./ Case
Scotch® Box Sealing Tape 311						
 195156	<ul style="list-style-type: none"> • General purpose box sealing tape designed specifically for utility type applications on light to medium weight boxes • Adheres instantly to a variety of surfaces, even in colder and damper environments • Conformable backing • Edge tear and split resistant • Good aging in sunlight or fluorescent lighting 	Polypropylene/ Pressure Sensitive Acrylic	Clear	48mm x 100mm	88292-0	36
				48mm x 1500mm	69398-4	6
				72mm x 100mm	69397-7	24
Tartan™ Box Sealing Tape 369						
 195358	<ul style="list-style-type: none"> • General purpose packaging tape used for non-critical applications • Low strength conformable backing • Edge tear and split resistance • Good holding power to fiberboard 	Polypropylene/ Hot Melt Rubber-Resin	Clear	48mm x 50mm	61551-1	36
				48mm x 100mm	61553-5	36
				48mm x 914mm	85258-9	6
				72mm x 100mm	61554-2	24
			Tan	48mm x 50mm	61547-4	36
48mm x 100mm	61549-8	36				
Tartan™ General Purpose Box Sealing Tape 305						
 195155	<ul style="list-style-type: none"> • General purpose packaging tape used for non-critical box sealing applications • A conformable backing • Good closure for lightweight boxes exposed to minimal distribution hazards 	Polypropylene/ Pressure Sensitive Acrylic	Clear	48mm x 100mm	39809-4	36
				48mm x 914mm	39810-0	6

3M™ Box Sealing Tape Dispensers

Scotch® and Tartan™ brand hand-held dispensers are designed for use with specially formulated 3M box sealing tapes for improved ease of use.



NEW!
to Catalog

NEW!
to Catalog



Product Number/Description	Size	UPC (021200-)	Qty./Case
Scotch® Box Sealing Tape Dispenser H122			
 196837	48mm (2")	06925-3	6
Scotch® Low Noise Tape Dispenser H150			
 196835	48mm (2")	39518-5	6
Scotch® Low Noise Tape Dispenser H153			
 195182	72mm (3")	39820-9	6
Scotch® Box Sealing Tape Dispenser H180			
 195186	48mm (2")	19008-7	6

3M™ Box Sealing Tape Dispensers (cont.)



Product Number/Description		Size	UPC (021200-)	Qty./Case
Scotch® Box Sealing Tape Dispenser H183				
 195177	<ul style="list-style-type: none"> Recommended for center seam sealing of RSC boxes Metal and high-impact plastic construction for durability and long-life performance Hand-held dispenser features adjustable tape break 	72mm (3")	61850-5	5
Scotch® Box Sealing Tape Dispenser H192				
 196838	<ul style="list-style-type: none"> Tape tension can be controlled with tape roll break High impact plastic construction 	48mm (2")	86512-1	6
Tartan™ Box Sealing Hand Dispenser HB933				
 196847	<ul style="list-style-type: none"> Seals cartons easily and secures a smooth, one-handed roll-on motion Unique spring-loaded bar maintains constant tension during tape application For tape rolls up to 3" wide on a 3" core 	72mm (3")	22922-0	6

3M™ Duct Tapes











Product Number/Description	Backing/Adhesive	Total Thickness mils (mm)	Temperature Range °F (°C)	Color	Size	UPC (051131-)	Qty./Case
3M™ Multi-Purpose Duct Tape 3900							
 150221	Polycoated Cloth/Rubber	7.7 (.020)	Up to 200°F (93°C)	Silver	48mm x 54.8m	06976-3	24
				Color	Size	UPC (021200-)	Qty./Case
				Black	48mm x 54.8m	49833-6	24
				Yellow		49828-2	
3M™ Vinyl Duct Tape 3903							
 69452	Embossed Vinyl/Rubber	6.3 (0.16)	Up to 250°F (121°C)	Color	Size	UPC (051131-)	Qty./Case
				Gray	2" x 50 yds.	06984-8	24
				Black		06995-4	
Yellow	06982-4						
3M™ Performance Plus Duct Tape 8979							
 352555	Polyethylene film over cloth scrim/Natural and Synthetic Rubber	12.6 (0.33)	Up to 200°F (93°C)	Color	Size	UPC (048011-)	Qty./Case
				Slate Blue	24mm x 54.8m	53922-5	48
				Color	Size	UPC (021200-)	Qty./Case
				Slate Blue	48mm x 54.8m	56468-0	24
72mm x 54.8m	56469-7	12					
96mm x 54.8m	56470-3						

Note: The technical information and data on these pages should be considered representative or typical only and should not be used for specification purposes.

3M™ Particulate Respirators

IMPORTANT: Before use of these respiratory protection products, a written respiratory protection program must be implemented, meeting all the requirements of OSHA 29 CFR 1910.134 such as training, fit testing, medical evaluation and applicable OSHA substance specific standards.

PLEASE NOTE: All products contain Advanced Electret Media, noseclip and two straps.

Particulate Respirator	3M™ Particulate Respirator	Suggested Application	Nose Foam	3M™ Cool Flow™ Valve	Braided Comfort Strap	Carbon Media	Nose-clip	Welding Web	Adj. Straps	Individual Additional Features	UPC (051131-)	Qty./Case	
Dusty Conditions													
 193020 8000, N95	Particulate Respirator 8000, N95						S				52967-5	240	
 4893 8210, N95	8210, N95	Grinding, Bagging, Sanding, Sweeping, Other dusty operations	●				S			Patented Filter Media	UPC (051138-)	160	
 185016 8210 Plus, N95	8210 Plus, N95		●		●	S			52924-8				
 4900 8271, P95	8271, P95		Grinding, Machining, Sanding, Sweeping, Other dusty/hot/oily operations		●	●	M				Patented Filter Media, Faceseal Ring		54285-1
 4899 8511, N95	8511, N95			●	●		M			Patented Filter Media	54343-8		
 12411 9210, N95	9210, N95	Grinding, Bagging, Sanding, Sweeping, Other hot/dusty operations	●				S			Patented Filter Media, Individual Packaging, Collapse Resistant	UPC (051131-)	240	
 12412 9211, N95	9211, N95		●	●		S			37022-2		120		
Metal Pouring													
 4894 8212, N95 Faceseal Ring	Welding Respirator 8212, N95 Faceseal Ring	Welding, Torch cutting, Brazing, Soldering, Metal pouring		●	●		S	●	●	Patented Filter Media, Faceseal Ring, Cake Resistant Media	UPC (051138-)	80	
 4895 8214, N95 Vapor Relief*	Welding Respirator 8214, N95, Vapor Relief*		Welding, Torch cutting, Brazing, Soldering, Metal pouring, Stainless, Galvanized		●	●	●	S	●		●		66192-7
 50662 8515, N95	8515, N95		Welding, Torch cutting, Brazing, Soldering		●	●		M	●				Patented Filter Media

* OV: 3M recommended for relief against nuisance levels of organic vapors. Nuisance level refers to concentrations not exceeding the OSHA PEL or applicable government exposure limits, whichever is lower.

** OZ: 3M recommended for ozone protection up to 10 times the OSHA PEL or applicable government occupational exposure limits, whichever is lower. Not NIOSH approved for use against ozone.

S = Standard noseclip M = M-noseclip

3M™ Particulate Respirators (cont.)

Patented Technologies



Cool Flow™ Exhalation Valve.
Patented one-way valve for easy exhalation and cool, dry comfort.



Advanced Electret Media.
Electrostatically charged microfibers help make breathing easier and cooler.



Adjustable Buckle Straps.
A single tug helps provide a comfortable, secure fit.



M-noseclip.
Adjusts easily for fewer pressure points and greater comfort.



Carbon Filter Material.
Carbon layers remove many nuisance level odors* for greater wearer comfort.



P-series Filter.
Featuring Advanced Electret Media, appropriate for prolonged use in oil and non-oil containing environments.



Faceseal.
Soft and secure, conforms closely to face for long-lasting comfort.



Cake-resistant Filter Media.
Specially designed filter layers for welding provide longer respirator life and easier breathing.

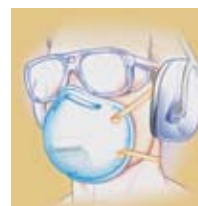

Compatibility.
Accommodates a wide range of safety equipment, including eye and hearing protection.

* Nuisance level odors refers to concentrations not exceeding the OSHA PEL or other applicable government exposure limits, whichever is lower.

3M™ Full and Half Facepiece Elastomeric Respirators

Respirator and filters provide an easy-to-use, comfortable, wide range of respiratory protection.

Applications: Using a variety of applications including painting, welding, metalworking and auto manufacturing (when used with appropriate cartridges, filters or supplied air).

1. Choose Facepiece

Half Facepiece

5000 Series

Features and Benefits

- Made from soft, lightweight thermoplastic elastomer
- No ongoing maintenance necessary
- Resealable storage bag helps keep respirator clean between uses
- Low profile design provides wider field of vision and greater comfort while wearing goggles or glasses
- For convenience and simplicity, some respirator package assemblies are package 3M™ Filters P95 or P100 along with 3M™ Filter Retainers 501 or 3M™ Filter Adapters 502



5061

6000 Series

Features and Benefits

- Made from soft, lightweight thermoplastic elastomer
- Easy to adjust head straps
- Supplied with reclosable storage bag
- Swept back design improves balance and visibility
- NIOSH approved for negative pressure air purifying and positive pressure dual airline applications
- Can be used with 3M™ Filters and Cartridges or 3M™ Dual Airline System

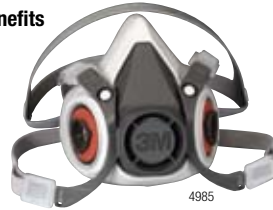

4985

7500 Series

Features and Benefits

- Made from soft, resilient silicone and heat resistant plastics
- Unique head harness design gives the user the option of wearing the respirator in traditional or drop-down mode
- 3M™ Cool Flow™ Exhalation Valve makes breathing easier, and helps reduce heat and moisture buildup in the facepiece and provides cool, dry comfort



126155



158805

Full Facepiece

6000 Series

Features and Benefits

- Soft, silicone face seal
- Four strap suspension for easy donning and doffing
- Bayonet attachment
- Swept back cartridge design
- Wide field of vision
- Meets all the requirements of ANSI Z87.1-2003 for high impact (Z87+)
- Integrated optical correction limits distortion as you look from the left to the right
- Directs exhaled breath and moisture downward
- Smooth surface allows for quick and easy cleaning
- Available with negative pressure and dual airline models only



276370

7800S Series

Features and Benefits

- Double-flange face seal and six adjustable straps help provide a secure fit
- Made of silicone for increased comfort and durability
- Extra-large inhalation and exhalation valves help make breathing easier
- Use with 3M™ Filters and Cartridges and/or a variety of powered and supplied air systems

















4973

Product	Model	Size	UPC (051138-)	Qty./Case
3M™ Half Facepiece Respirator				
5000 Series	51P71	S	66068-5	12
	52P71	M	66069-2	
	53P71	L	66070-8	
Product	Model	Size	UPC (051131-)	Qty./Case
6000 Series	6100	S	07024-5	24
	6200	M	07025-2	
	6300	L	07026-9	
7500 Series	7501	S	37081-9	10
	7502	M	37082-6	
	7503	L	37083-3	

Product	Model	Size	UPC (051131-)	Qty./Case
3M™ Full Facepiece Respirator				
6000 Series	6700	S	54145-8	4
	6800	M	54146-5	
	6900	L	54159-5	
Product	Model	Size	UPC (051138-)	Qty./Case
7800S Series	7800S-S	S	54257-3	1
	7800S-M	M	54258-0	
	7800S-L	L	54259-7	

Note: Employer must provide a minimum of Grade D breathing air in accordance with OSHA requirements.

2. Choose Filter/Cartridge Combination

Filter/Cartridge	NIOSH Approval**	UPC (051131-)	Qty./ Case	Respirators	Filter Retainer/ Adapter	UPC (051138-)	Qty./ Case
Particles							
 4911 2091-P100	<ul style="list-style-type: none"> • P100 Particulate Filter • NIOSH approved for environments containing certain oil and non-oil based particles 	07000-9	50 pairs	5000 Series 6000 Series and 7000 Series	 Filter Adapter 502	21511-3	100
 89287 2097-P100	<ul style="list-style-type: none"> • P100 Filter with nuisance level organic vapor relief* (Nuisance levels refer to concentrations below the OSHA Permissible Exposure Limit [PEL]) • NIOSH approved for environments containing certain oil and non-oil based particles 	07184-6		6000 Series and 7000 Series			
 425866 7093C-P100	<ul style="list-style-type: none"> • Hydrogen Fluoride, P100 filter with nuisance level organic vapor and acid gas relief*** • Very low breathing resistance for improved comfort • Unique, lightweight and compact hard case design 	37173-1	60	6000 Series and 7000 Series			
 120358 7093-P100	<ul style="list-style-type: none"> • P100 Particulate Filter 	52705-3	72	5000 Series 6000 Series and 7000 Series	 Filter Retainer 501	17668-1	
 7207 5P71-P95	<ul style="list-style-type: none"> • Replacement Particulate P95 Filter 5P71 	051138- 66278-8		5000 Series 6000 Series and 7000 Series			
Gases and Vapors							
 7209 6001	<ul style="list-style-type: none"> • Certain organic vapors (a) (b) 	21674-5	30 pairs	6000 Series and 7000 Series	 Filter Retainer 501	21511-3	100
 7211 6003	<ul style="list-style-type: none"> • Certain organic vapors, chlorine, hydrogen chloride and sulfur dioxide or hydrogen sulfide (escape only) or hydrogen fluoride (a) (b) 	07047-4					
 7216 6006	<ul style="list-style-type: none"> • Certain organic vapors, chlorine, hydrogen chloride, chlorine dioxide, sulfur dioxide, hydrogen sulfide (escape only), ammonia/methylamine, formaldehyde or hydrogen fluoride (a) (b) (c) 	54186-1					
Particles and Vapors							
 44880 60921	<ul style="list-style-type: none"> • P100/Certain organic vapors (a) (b) 	46465-8	30 pairs	6000 Series and 7000 Series	 Filter Adapter 502	21511-3	100
 44878 60923	<ul style="list-style-type: none"> • P100/Certain organic vapors, chlorine, hydrogen chloride and sulfur dioxide or hydrogen sulfide (escape only) or hydrogen fluoride (a) (b) 	46467-2					
 44875 60926	<ul style="list-style-type: none"> • P100/Certain organic vapors, chlorine, hydrogen chloride, chlorine dioxide, sulfur dioxide, hydrogen sulfide (escape only), ammonia/methylamine, formaldehyde or hydrogen fluoride (a) (b) (c) 	54187-8					

* 3M recommended for relief against nuisance levels of organic vapors. Nuisance level organic vapor refers to concentrations not exceeding the OSHA PEL or applicable government occupational exposure limits, whichever is lower.

** For respiratory protection against the following contaminants up to 10X PEL with half facepiece respirators:

(a) All respirators and respirator assemblies can be used up to the NIOSH approval limits, 10X PEL for half facepiece respirators, or 50X PEL for full facepiece respirators when quantitatively fit tested, or the maximum use concentration allowable in applicable OSHA standards, whichever is lower.

(b) For specific usage, limitations and warning information, see packaging, *User Instructions*, or call 3M OH&ESD Technical Service at 1-800-243-4630.



(c) OSHA regulations require that gas-proof goggles be worn with half facepiece respirators when used against formaldehyde.

*** 3M recommended for relief against nuisance levels of organic vapor and acid gases. Nuisance level organic vapor and acid gas refers to concentrations not exceeding OSHA PEL or applicable government occupational exposure limits, whichever is lower. Not NIOSH-approved for organic vapors or acid gases. Do not use for respiratory protection against organic vapors or acid gases (except hydrogen fluoride).

3M™ Speedglas™ Auto-Darkening Filters and Helmets

3M™ Speedglas™ Helmets and Auto-Darkening Filters						
 <p>Utility Filter and Helmet</p>	 <p>9000XF Filter and Helmet</p>	 <p>9002D Filter and Helmet</p>	 <p>9002V Filter and Helmet</p>	 <p>9002X Filter and Helmet</p>	 <p>SL (Super Light) Filter and Helmet</p>	
 <p>Utility Filter</p> <ul style="list-style-type: none"> • Helmet and filter • Single shade • Available in shades 10 or 11 • MIG and Stick 	 <p>9000XF Filter</p> <ul style="list-style-type: none"> • Extra large viewing area • Single shade • Available in shades 10, 11 or 12 • MIG, Stick, some TIG • Sensitivity adjustment • Solar panel maximizes battery life • Replaceable batteries 	 <p>9002D Filter</p> <ul style="list-style-type: none"> • Variable shade 10 and 11 • MIG, Stick, most TIG • Two sensitivity settings • Membrane-covered control buttons • Replaceable batteries 	 <p>9002V Filter</p> <ul style="list-style-type: none"> • Variable shade 9 thru 13 • MIG, Stick, and TIG • Four sensitivity settings • Three delay settings • Membrane-covered control buttons • Replaceable batteries 	 <p>9002X Filter</p> <ul style="list-style-type: none"> • Extra large viewing area • Variable shade 9 thru 13 • MIG, Stick, and TIG • Four sensitivity settings • Three delay settings • Membrane-covered control buttons • Solar panel maximizes battery life • Replaceable batteries 	 <p>SL Filter</p> <ul style="list-style-type: none"> • Lightest Speedglas helmet available—just 13 oz. (370g) • Variable shade 8 thru 12 • MIG, Stick, and TIG • Four sensitivity settings • Patented auto on/off technology • Replaceable batteries 	
	Utility	9000XF	9002D	9002V	9002X	SL
Standard Helmet	04-0014-10U	04-0012-10X	04-0012-15	04-0012-31	04-0012-21	05-0013-41
Standard Helmet with SideWindows	N/A	04-0012-10XSW	040012-15SW	04-0012-31SW	04-0012-21SW	N/A
ProTop System	N/A	04-0015-10X	04-0015-15	04-0015-31	04-0015-21	N/A
ProTop System with SideWindows	N/A	04-0015-10XSW	04-0015-15SW	04-0015-31SW	04-0015-21SW	N/A
FlexView System	N/A	04-0016-10X	04-0016-15	04-0016-31	04-0016-21	N/A
FlexView System with SideWindows	N/A	04-0016-10XSW	04-0016-15SW	04-0016-31SW	04-0016-21SW	N/A
FlexView System with ProTop	N/A	04-1516-10X	04-1516-15	04-1516-31	04-1516-21	N/A
FlexView System with ProTop and SideWindows	N/A	04-1516-10XSW	04-1516-15SW	04-1516-31SW	04-1516-21SW	N/A

3M™ Welding Products

Product Number/Description	Shade	UPC (051131-)	Qty./Case
3M™ Welding Shield WS-Series			
<ul style="list-style-type: none"> • Three variable dark state shade levels (ADF shades 10-12) • Two user-selectable sensitivity levels for reliable arc detection • For stick, MIG/MAG and for many TIG welding applications • Good optical quality for clear view of the workplace • Shade 4 in the light state • Easy to operate and maintain • Shield is designed to help protect the wearer's eyes from harmful radiation, including visible light, ultraviolet radiation (UV) and infrared radiation (IR) resulting from certain welding processes 			
 337247	3M™ Welding Auto-Darkening Filter Variable Shade 10-12 WS-020	Variable Shade 10-12	37154-5
 337237	3M™ Passive Welding Shield WS-110	(non-ADF), Shade 10	37155-2
			1

3M™ Portable Gas Detectors

Product Number/Description	Model	UPC (051131-)	Qty./Case
3M™ Single Gas Detector 110 Series			
 441619 NEW! to Catalog	<ul style="list-style-type: none"> • Lightweight and compact • Easy, one-button operation • Long-lasting lithium battery • Three alarm indicators • O₂, CO, H₂S 	110-495-100, Oxygen (OX)	98566-7
		110-495-101-XL, Carbon Monoxide (CO)	98570-4
		110-495-102-XL, Hydrogen Sulfide (HS)	98571-1
			1

3M™ Hearing Protection

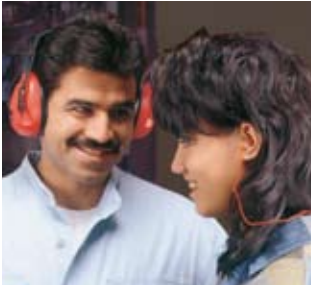

3M offers a wide variety of solutions to help reduce noise exposure. A full line of comfortable, easy-to-use hearing protectors, including ear plugs, ear muffs, and banded hearing protectors are available from 3M.

Product Number/Description	Model	UPC (051138-)	Qty./Case	
3M™ Foam Ear Plug 1100 and 3M™ Corded Foam Ear Plug 1110				
<p>247043</p> <p>247035</p>	<ul style="list-style-type: none"> • Smooth dirt resistant surface and tapered shape fit the ear canal and provide added comfort and hygiene • Hypo-allergenic material • Each package is easy to dispense • Noise Reduction Rating: 29dB* • Available in corded and uncorded versions 	1100 (uncorded)	29008-0	1000 Pairs
		1110 (corded)	29009-7	500 Pairs
Product Number/Description	Model	UPC (051131-)	Qty./Case	
3M™ Soft Foam Ear Plug 1120 and 3M™ Corded Soft Foam Ear Plug 1130				
<p>167550</p> <p>167550</p>	<ul style="list-style-type: none"> • Soft foam helps reduce pressure in the ear canal for improved comfort • Patented articulated shape for improved fit. • Rolls down small for easier insertion and fit for small ear canals • Hypo-allergenic material • Bright orange color for visibility • Combine with ear muffs for additional protection • Noise Reduction Rating: 28dB* • Available in corded and uncorded versions 	1120 (uncorded)	37062-8	1000 Pairs
		1130 (corded)	37063-5	500 Pairs
3M™ Reusable Ear Plug 1260, Uncorded, 3M™ Reusable Ear Plug 1271, Corded, with Carrying Case				
<p>150831</p>	<ul style="list-style-type: none"> • Multi-flanged plugs stay securely in ear canal • Soft cloth cord lays flat • Washable and reusable • Bright orange color for visibility • Noise Reduction Rating: 24dB* • Available in corded, uncorded and corded with carrying case 	1260 (uncorded)	52845-6	500 Pairs
		1270 (corded)	52849-4	
		1271 (corded with carrying case)	52850-0	250 Pairs
3M™ Reusable Ear Plugs 1290 Series				
<p>429299</p>	<ul style="list-style-type: none"> • New, translucent blue • Softer, flexible material for better comfort • Two corded options: soft, braided cord or plastic cord • 3-flange design fits securely in the ear • Finger grip stem for easy insertion and to help keep ear plugs clean • Elastic material does not contain silicone, so earplugs may be used in sensitive work environments, such as automotive painting • Noise Reduction Rating: 25dB* 	1290/37184 (braided cord)	37184-2	500 Pairs
		1291/37185 (braided cord and storage case)	37185-9	250 Pairs
		1292/37186 (plastic cord)	37186-6	500 Pairs
		1293/37187 (plastic cord and storage case)	37187-3	250 Pairs

* The NRR may overestimate the protection provided during typical use. 3M recommends reducing the NRR by 50% for estimating the amount of noise reduction provided. See product packaging and warnings for specific information.

3M™ Hearing Protection (cont.)

Product Number/Description		Model	UPC (051138-)	Qty./Case
3M™ Banded Hearing Protector 1310 and 3M™ Replacement Pads 1311				
 <p>7681</p> <p>8840</p>	<ul style="list-style-type: none"> • Flexible band makes fitting easy • Maintains low pressure over a wide range of head sizes • Replacement tips are cost effective and easy to replace • Noise Reduction Rating: 21dB when worn behind the head and 20dB when worn under the chin* • Smooth, dirt resistant surface for hygiene 	1310 (Band)	66003-6	50 Pairs
		1311 (Replacement Pads)	66004-3	100 Pairs
Product Number/Description			UPC (051131-)	Qty./Case
Ear Plug Dispenser				
3M™ Foam Ear Plug Dispenser Assembly 1100-DP and 3M™ Soft Foam Ear Plug Dispenser Assembly 1120-DP				
<ul style="list-style-type: none"> • Durable, lightweight dispenser • Mounts on wall or sits on tabletop • Reduces need for individual package (plastic bags/pair)— reduction in waste and litter • Holds up to 700 pairs of plugs • Dispenser is refillable— eliminates need to recycle or dispose of bulky refill containers or single-use dispensers • Dispenses 3M™ Foam Ear Plugs 1100 and 3M™ Soft Foam Ear Plugs 1120 				
 <p>359531</p>	3M™ Foam Ear Plug Dispenser 1100-DP (assembly with 1000 pairs of Foam Ear Plug 1100, mounting bracket and catch tray— 1 assembly case)		91790-3	1
	3M™ Foam Ear Plug Dispenser 1120-DP (assembly with 1000 pairs of Soft Foam Ear Plug 1120, mounting bracket and catch tray— 1 assembly case)		37151-4	
	3M™ Foam Ear Plug 1100-R used to refill 3M™ Foam Ear Plug Dispenser (500 pairs/bag, 4 bags/case)		91789-2	2000 Pairs
	3M™ Foam Ear Plug 1120-R used to refill 3M™ Foam Ear Plug Dispenser (500 pairs/bag, 4 bags/case)		37153-3	
	3M™ Ear Plug Dispenser Base DSP-B			
Optional heavy base for 3M™ Foam Ear Plug Dispenser (when used on horizontal surfaces, such as counter or table tops (1 base/box, 4 boxes/case)			31752-6	4
Product Number/Description			UPC (051138-)	Qty./Case
3M™ Ear Muff 1440				
 <p>247039</p>	<ul style="list-style-type: none"> • Lightweight, padded headband with tension adjustment • Contoured ear cushion in multi-position ear cup gives enhanced fit • Replaceable cushions and molded noise suppression inserts • Noise Reduction Rating: 24dB* 		29334-0	20 Pairs
3M™ Ear Muff 1435				
 <p>7166</p>	<ul style="list-style-type: none"> • General purpose ear muffs • Wide, forked headband and multi-position large ear cup help create a secure fit • Lightweight design • Replaceable, soft sealing cushions • Noise Reduction Rating: 23dB* 		29333-3	20 Pairs

* The NRR may overestimate the protection provided during typical use. 3M recommends reducing the NRR by 50% for estimating the amount of noise reduction provided. See product packaging and warnings for specific information.

3M™ Protective Eyewear



3M eye protection products help provide wearer comfort, safety and a fashionable look. They are available in several designs to meet the needs of a wide variety of people and conditions.

Product Number/Description	Model	Color (Frame/Lens)	UPC (051138-)	Qty./Case
1700 Series				
 59082	1700	Black/Clear	37103-8	24
 323739	1701	Smoke/Smoke	76800-8	
Product Number/Description				
1750 Series				
 323757	1750	Gray/Clear	37113-7	24
 410302	1752	Blue/Mirrored	37115-1	
1760 Series				
 290312	1760	Clear/Clear	37116-8	24

Warnings

	<p style="text-align: center;">⚠ WARNING: RESPIRATORS</p> <p>No respirator is capable of preventing all airborne contaminants from entering the wearer's breathing zone. Respirators help protect against certain airborne contaminants by reducing concentrations in the breathing zone to below the PEL or other recommended exposure level. Misuse of respirators may result in overexposure to the contaminant and cause sickness or death. For this reason, proper respirator selection, training, use and maintenance are mandatory in order for the wearer to be properly protected. Use these respirators only for those specific chemical compounds for which they have been approved or recommended. For proper use, see supervisor, product instructions and warnings or call 3M Occupational Health and Safety Division (OH&ESD) Technical Service at 1-800-243-4630. In Canada, call 1-800-267-4414.</p>
---	---

<p>⚠ WARNING: WELDING PRODUCTS</p>	
<p>These welding safety products must be used only by qualified persons trained in their use and maintenance and only in strict accordance with and adherence to the detailed instructions and precautionary statements provided in the instruction manual which accompanies each product. Failure to comply with these instructions could result in sickness, serious bodily injury or death. For proper use of these products read <i>User Instructions</i> and WARNINGS on the package. Any questions concerning proper use should be directed to your supervisor, on-site training specialist, industrial hygienist or 3M Occupational Health and Safety Division (OH&ESD) Technical Service in the U.S.A. at 1-800-243-4630. In Canada, call 1-800-267-4414.</p>	

<p>⚠ WARNING: HEARING PROTECTION</p>	
<p>These hearing protection products help reduce exposure to certain noises. To provide proper protection, the hearing protector should be 1) suitable for the job, 2) fitted properly in/on the ear, 3) worn during all times of exposure to noise and 4) replaced when damaged or otherwise necessary. Misuse may result in hearing loss or injury. For proper use, see supervisor, product instructions and warnings or call 3M Occupational Health and Safety Division (OH&ESD) Technical Service at 1-800-243-4630. In Canada, call 1-800-267-4414.</p>	

<p>⚠ WARNING: PROTECTIVE EYEWEAR</p>	
<p>3M Protective Eyewear Products help provide limited eye protection against flying particles. Misuse or failure to follow warnings and instructions may result in serious personal injury, including blindness or death. For proper use see supervisor, read instructions and warnings on the package, or call 3M Occupational Health and Environmental Safety Division (OH&ESD) Technical Service in the U.S.A. at 1-800-243-4630.</p>	

<p>⚠ WARNING: SORBENTS</p>	
<p>Failure to properly handle and dispose of sorbents contaminated by hazardous materials can result in serious physical injury or death and/or environmental harm. For proper handling, consult the Material Safety Data Sheet for the material absorbed, applicable safety and health standards, contact your supervisor, or call 3M Occupational Health and Environmental Safety Division (OH&ESD) Technical Service at 1-800-243-4630. To reduce the risk of serious physical injury or death, always use respiratory protection and protective clothing appropriate for handling the material to be absorbed. Transportation and disposal of spent sorbents must comply with all applicable federal, state and local laws and regulations. Caution: Sorbents may become slippery when used on flooring. Do not walk on sorbent or place in high traffic areas.</p>	

<p>⚠ WARNING: DETECTION PRODUCTS</p>	
<p>This instrument helps monitor for the presence and concentration level of certain specified airborne gases. Misuse may produce an inaccurate reading which means that higher levels of the gas being monitored may be present and could result in overexposure and cause sickness or death. For instruments with an oxygen sensor installed, misuse may produce an inaccurate reading where lower or higher levels of oxygen may be present and cause sickness or death.</p>	
<p>Each person using this equipment must read and understand the information in the <i>User Instructions</i> before use. Use of this equipment by untrained or unqualified persons, or use that is not in accordance with the <i>User Instructions</i>, may adversely affect product performance and result in sickness or death. For proper use, see supervisor or <i>User Instructions</i>, or call 3M Occupational Health and Environmental Safety Division (OH&ESD) Technical Service in the U.S.A. at 1-800-243-4630. In Canada, call at 1-800-267-4414.</p>	

3M™ Sorbents



3M™ Maintenance Sorbents: Fast acting, highly absorbent, easy to use and absorb almost any type of non-aggressive liquids such as oils, coolants, hydraulic fluids and water. Its high fluid capacity means the need to change the sorbent is less frequent, saving on material, labor and disposal costs.



3M™ Petroleum Sorbents: Sorbs oil and other petroleum-based liquids while repelling water. Available in a variety of configurations to best suit your needs including: folded, pads, booms, pillows, sweeps, rolls and drum covers.

Product Number/Description	Model	Size	UPC (051138-)	Qty./Case
3M™ Maintenance Sorbents				
Folded M-FL550DD, High Capacity				
<p>3835</p> <ul style="list-style-type: none"> • Easy-to-use solution for cleaning up spills, drips and fluid leaks • Versatile: can be used in pillow, pad, roll or boom configuration • Scrim on one side to increase strength and help eliminate linting • Dispenses from a carrying/dispenser box in the form of a continuous roll • Less waste: perforated every 16 inches so you can select the length required • Absorbs 31.5 gallons per case • Applications range from maintenance to spill response 	M-FL550DD	5" x 50'	29071-9	3
Rug M-RG36300E				
<p>3841</p> <ul style="list-style-type: none"> • Use in areas where foot and vehicle traffic is a concern • Will sorb non aggressive liquids while enduring the punishment of being tread upon • Durable and versatile • Use in industrial maintenance applications • Absorbs 32 gallons per rug 	M-RG36300E	36" x 300'	29002-3	1
Mini-Boom				
<p>3840</p> <ul style="list-style-type: none"> • Tube-like shape is ideal for placing around machinery to contain spills and prevent leaks from spreading into adjacent work areas • 3 inch diameter scrim on the outside of the boom identifies the use while containing particulate sorbent material designed for the application • Absorbs 12 gallons per case 	M-MB304	3" x 4'	21526-7	12
	M-MB308	3" x 8'	21527-4	6
3M™ Petroleum Sorbents				
Pad HP-156, High Capacity				
<p>6756</p> <ul style="list-style-type: none"> • Low-profile design can be easily placed in tight areas • Ideal for cleaning up small spills and wiping down contaminated areas • Has a scrim on one side to increase strength and help eliminate linting • Conveniently sized, allows the user to quickly spread sorbent over and in the path of a spill • Can also be used on a work surface in anticipation of a spill or as a wipe • Absorbs 37.5 gallons per bale 	HP-156	17" x 19"	28911-4	100
Product Number/Description				
Pad T-151				
<p>6714</p> <ul style="list-style-type: none"> • This highly sorbent pad features a low-profile design for easy placement in tight areas • Ideal for cleaning up small spills and wiping down contaminated areas • Absorbs 43.5 gallons per bale 	T-151	17" x 19"	16049-3	200

3M™ Cleaners



3M™ Cleaners: 3M's line of aerosol cleaners are the fast and easy solution for removing grease, grime, inks, and residues on electrical equipment and components.

Product Number/Description	Size	UPC (021200-)	Qty./Case
3M™ 5-Way Penetrant			
 <p>243698</p> <ul style="list-style-type: none"> • Inhibits rust and corrosion by spreading a thin, even film that actually penetrates the pores of the surface • It displaces moisture and “dries out” electrical parts and equipment to help prevent shorting and increase conductivity • Spray it on to free rusted, frozen bolts, nuts, and screws • Lubricate delicate machines and precision instruments • Penetrates and demoisturizes • Ideal as a tapping lubricant for stainless steel and aluminum • Contains no methylene chloride, 1, 1, 1-trichloroethane or chlorofluorocarbons 	24 fl. oz.	21305-2	12
3M™ Citrus Base Cleaner			
 <p>243700</p> <ul style="list-style-type: none"> • Multi-purpose cleaner • Will dissolve and flush away dirt, grease, tar, most noncuring type adhesive films and similar substances • Citrus oil-based cleaner that emulsifies when flushed with water • Contains no petroleum distillates • Use to clean and degrease metal parts, motors, tools, printing presses and concrete • Contains no methylene chloride, 1, 1, 1-trichlorofluorocarbons 	24 fl. oz.	76394-6	12
Product Number/Description	Size	UPC (048011-)	Qty./Case
3M™ Stainless Steel Cleaner and Polish			
 <p>221761</p> <ul style="list-style-type: none"> • Cleans and polishes stainless steel, chrome aluminum and laminated plastic surfaces • High gloss in one step • Contains no ozone depleting chemical 	21 fl. oz.	14002-0	12

Concrete Repair



Cracks and spalls in concrete floors are an eyesore as well as a potential safety risk. Fixing them has meant either hiring and waiting for an outside contractor or doing it yourself with a repair method that takes the floor out of service for up to 24 hours. Now with 3M™ Concrete Repair, you save money and time.

Product Number/Description	Work Life	Handling Time	Cure Time	Color	Size	UPC (021200-)	Qty./Case
3M™ Concrete Repair DP-600—Horizontal							
 <ul style="list-style-type: none"> • Flows smoothly into cleaned cracks and gaps • Hardens to any depth without cracking or shrinking • Flexible urethane expands and contracts for durability that outlasts repairs made with concrete • Solvent-free 	70 sec.	5 min.	60 min.	Gray	8.4 fl. oz. (250mL Cartridge)	96596-8	6



3M™ Electrical Products

Product Number/Description	Size	UPC (054007-)	Qty./Case
Scotch® Vinyl Electrical Tape Super 33+			
 <ul style="list-style-type: none"> • Provides primary electrical insulation for splices up to 600V • Abrasion corrosion and UV-resistant • Makes an excellent protective jacketing for high-voltage cables and wire harnessing • UL listed and CSA certified • Resists alkalis and acids, flame retardant • Excellent all-weather performance in cold to 0°F (-18°C) or hot to 220°F (105°C) 	3/4" x 66'	06132-8	100

3M™ Facility Care Products

3M™ Safety-Walk™ Matting

Spring-coiled vinyl foam compresses uniformly and continually, providing greater comfort and less fatigue.

Product Number/Description	Color	Size	UPC (048011-)	Qty./Case
3270 (No Edging)				
 <p>31783</p> <ul style="list-style-type: none"> Economical matting ideal for fatigue resistance in dry environments Textured, solid surface improves traction and allows debris and liquid to stay on top of the mat for easy cleanup Lightweight for easy moving and repositioning No edging 	Black	3' x 5'	34819-3	1
		3' x 10'	34821-6	
		3' x 20'	34823-0	
		4' x 20'	34824-7	
3270E (Black Edging)				
 <p>31783</p> <ul style="list-style-type: none"> Economical matting ideal for fatigue resistance in dry environments Textured, solid surface improves traction and allows debris and liquid to stay on top of the mat for easy cleanup Lightweight for easy moving and repositioning Integral edging on the long edge of the mat and nosing on the ends 	Black with Black Edging	3' x 5'	34826-1	1
		3' x 10'	34828-5	
		3' x 20'	34830-8	
		4' x 20'	34831-5	

Utility Cloth Sheets and Rolls

3M™ Portable Utility Roll 314D

Product Number/Description	W x L	Grade	UPC (051141-)	Qty./Case
Utility Rolls				
 <p>NEW! to Catalog</p> <ul style="list-style-type: none"> Portable for ease of use at jobsite Protective plastic pack resists dirt, oil, water and serves as a convenient dispenser Aluminum oxide abrasive product sheets constructed on X- or J-weight, durable cloth backing 	1" x 8 yds.	P60 X	20963-0	1/5
	1" x 12 yds.	P60 J	20964-7	
	1" x 16 yds.	P120 J	20965-4	
	1" x 20 yds.	P180 J	20966-1	
		P240 J	20967-8	
1" Portable Utility Roll Kit			20968-0	1/5
Kit contains one (1) each of the above utility rolls				

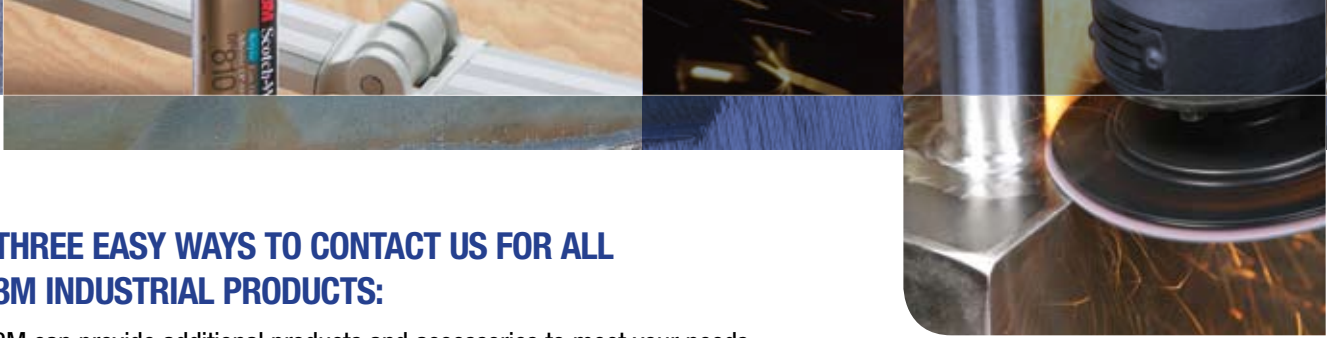

THREE EASY WAYS TO CONTACT US FOR ALL 3M INDUSTRIAL PRODUCTS:

3M can provide additional products and accessories to meet your needs. Please contact us in any of the following ways that you prefer:

Contact your local 3M authorized distributor directly. For information on a 3M distributor or sales representative in your area, contact us at the numbers below:

For the contiguous 48 United States:

Call 1-866-279-1288 ext. 8005
Fax 1-877-369-2923

For:

Alaska 907-522-5200
Canada 519-451-2500
Hawaii 808-422-2721
Northern Mexico 915-856-5035
Puerto Rico 787-750-3000

E-mail us at 3MIndustrial@mmm.com

For additional 3M product information or material data sheets call 1-800-3M Helps or visit us at www.3M.com

Prices subject to change without notice.

Important Notice to Purchaser

Safety Information: Always read and follow all safety information included with the product. Do not exceed maximum operating RPM's. Use guards provided with machine. Follow safety operation procedures posted in work areas.

Product Use: All statements, technical information and recommendations contained in this document are based upon tests or experience that 3M believes are reliable. However, many factors beyond 3M's control can effect the use and performance of a 3M product in a particular application, including the conditions under which the product is used and the time and environments conditions in which the product is expected to perform. Since these factors are uniquely within the user's knowledge and control, it is essential that the user evaluate the 3M product to determine whether it is fit for a particular purpose and suitable for the user's method of application.

Warranty and Limited Remedy: Unless stated otherwise in 3M's product literature, packaging inserts or product packaging for individual products, 3M warrants that each 3M product meets the applicable specifications at the time 3M ships the product. Individual products may have additional or different warranties as stated on product literature, package inserts or product packages. 3M MAKES NO OTHER WARRANTIES, EXPRESS OR IMPLIED, INCLUDING, BUT NOT LIMITED TO, ANY IMPLIED WARRANTY OF MERCHANTABILITY OR FITNESS FOR A PARTICULAR PURPOSE OR ANY IMPLIED WARRANTY ARISING OUT OF A COURSE OF DEALING, CUSTOM OR USAGE OF TRADE. User is responsible for determining whether the 3M product is fit for a particular purpose and suitable for user's application. If the 3M product is defective within the warranty period, your exclusive remedy and 3M's and seller's sole obligation will be at 3M's option, to replace the product or refund the purchase price.

Limitation of Liability: Except where prohibited by law, 3M and seller will not be liable for any loss or damage arising from the 3M product, whether direct, indirect, special, incidental, or consequential, regardless of the legal theory asserted, including warranty, contract, negligence, or strict liability.



Industrial Business

Customer Response Center
900 Bush Avenue, Building 21-1W-10
St. Paul, MN 55106

Please Recycle. Printed in U.S.A.
© 3M 2008. All rights reserved.
61-5002-8097-1

3M, Cool Flow, Cubitron, EPX, Green Corps, Hookit, Jet-Weld, Roloc, Safety-Walk, Scotch, Scotch-Brite, Scotch-Grip, Scotch-Weld, Scotchblok, Scotchpro, Speedglas, Stikit, Tartan, Trizact, VHB and Wetordry are all trademarks of 3M.